

*Thinking of you*

 **Electrolux**

User Manual

Washing Machine

EWF 14170 W



**We were thinking of you**  
when we made this product

## **Welcome to the world of Electrolux**

Thank you for choosing a first class product from Electrolux, which hopefully will provide you with lots of pleasure in the future. The Electrolux ambition is to offer a wide variety of quality products that make your life more comfortable. You find some examples on the cover in this manual. Please take a few minutes to study this manual so that you can take advantage of the benefits of your new machine. We promise that it will provide a superior User Experience delivering Ease-of-Mind. Good luck!

# Contents

Safety information.....5  
Product description .....7  
Control panel.....8  
Use.....9  
Washing hints .....15  
International wash code symbol .....18  
Washing programme .....19-20  
Programme information .....21  
Care and cleaning .....22  
Something not working.....25  
Techical data .....29  
Consumption values .....30  
Installation .....31  
Environment concerns .....35  
Guarantee conditions .....36  
Customer service centres .....37

The following symbols are used in this manual:



Important information concerning your personal safety and information on how to avoid damaging the appliance.



General information and tips



Environmental information

## Safety Information



**In the interest of your safety and to ensure the correct use, before installing and first using the appliance, read this user manual carefully, including its hints and warnings. To avoid unnecessary mistakes and accidents, it is important to ensure that all people using the appliance are thoroughly familiar with its operation and safety features. Save these instructions and make sure that they remain with the appliance if it is moved or sold, so that everyone using it through its life will be properly informed on appliance use and safety.**

### General safety

- It is dangerous to alter the specifications or attempt to modify this product in any way.
- During high temperature wash programmes the door glass may get hot. Do not touch it!
- Make sure that small pets do not climb into the drum. To avoid this, please check into the drum before using.
- Any objects such as coins, safety pins, nails, screws, stones or any other hard, sharp material can cause extensive damage and must not be placed into the machine.
- Only use the advised quantities of fabric softener and detergent. Damage to the fabric can ensue if you over-fill. Refer to the manufacturer's recommendations of quantities.
- Wash small items such as socks, laces, washable belts etc in a washing bag or pillow case as it is possible for such items to slip down between the tub and the inner drum.
- Do not use your washing machine to wash articles with whalebones, material without hems or torn material.
- Always unplug the appliance and turn off the water supply after use, clean and maintenance.
- Under no circumstances should you attempt to repair the machine yourself. Repairs carried out by inexperienced persons may cause injury or serious malfunctioning. Contact your local Service Centre. Always insist on genuine spare parts.

### Installation

- This appliance is heavy. Care should be taken when moving it.
- When unpacking the appliance, check that it is not damaged. If in doubt, do not use it and contact the Service Centre.
- All packing and transit bolts must be removed before use. Serious damage can occur to the product and to property if this is not adhered to. See relevant section in the user manual.
- After having installed the appliance, check that it is not standing on the inlet and drain hose and the worktop is not pressing the electrical supply cable.
- If the machine is situated on a carpeted floor, please adjust the feet in order to allow air to circulate freely
- Always be sure, that there is no water leakage from hoses and their connections after the installation.

## 6 electrolux **safety information**

- If the appliance is installed in a location subject to frost, please read the “**dangers of freezing**” chapter.
- Any plumbing work required to install this appliance should be carried out by a qualified plumber or competent person.
- Any electrical work required to install this appliance should be carried out by a qualified electrician or competent person.

### **Use**

- This appliance is designed for domestic use. It must not be used for purposes other than those for which it was designed.
  - Only wash fabrics which are designed to be machine washed. Follow the instructions on each garment label.
  - Do not overload the appliance. See the relevant section in the user manual.
  - Before washing, ensure that all pockets are empty and buttons and zips are fastened. Avoid washing frayed or torn articles and treat stains such as paint, ink, rust, and grass before washing. Underwired bras must NOT be machine washed.
  - Garments which have been in contact with volatile petroleum products should not be machine washed. If volatile cleaning fluids are used, care should be taken to ensure that the fluid is removed from the garment before placing in the machine.
  - Never pull the power supply cable to remove the plug from the socket; always take hold of the plug itself.
- Never use the washing machine if the power supply cable, the control panel, the working surface or the base are damaged so that the inside of the washing machine is accessible.

### **Child safety**

- This washing machine is not intended for use by young children or infirm persons without supervision.
- Young children should be supervised to ensure that they do not play with the appliance.
- The packaging components (e.g. plastic film, polystyrene) can be dangerous to children - danger of suffocation! Keep them out of children's reach
- Keep all detergents in a safe place out of children's reach.
- Make sure that children or pets do not climb into the drum. To avoid this the machine incorporates special feature. To activate this device, rotate the button (without pressing it) inside the door clockwise until the groove is horizontal. If necessary use a coin.

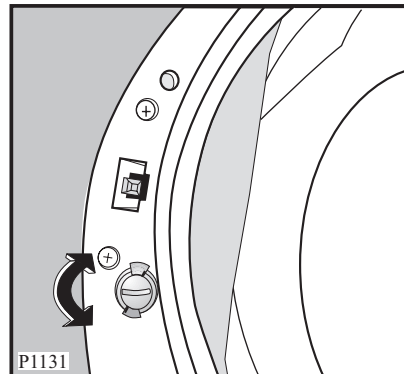

To disable this device and restore the possibility of closing the door, rotate the button anti-clockwise until the groove is vertical.

## Product description

Your new appliance meets all modern requirements for effective treatment of laundry with low water, energy and detergent consumption.

The **ECO valve** system allows total use of detergent and reduces water consumption so saving energy.

- 1** Detergent dispenser drawer
- 2** Control panel
- 3** Door opening handle
- 4** Drain pump
- 5** Adjustable feet

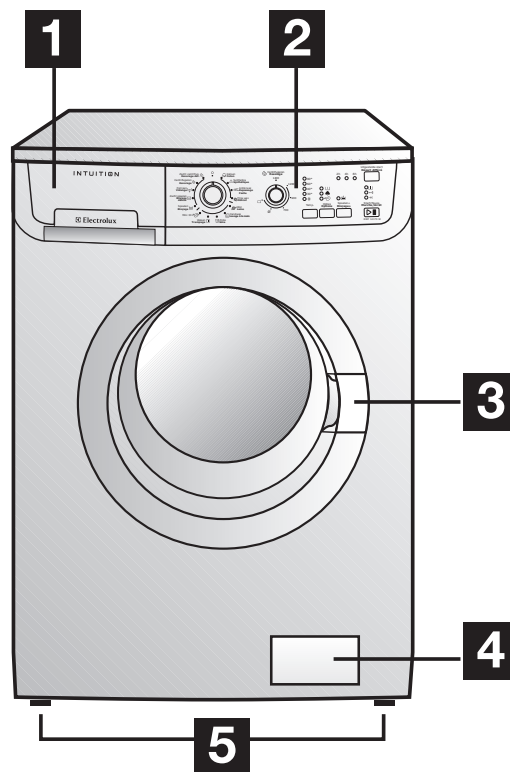

### Detergent dispenser drawer

-  Prewash
-  Wash
-  Fabric Softener

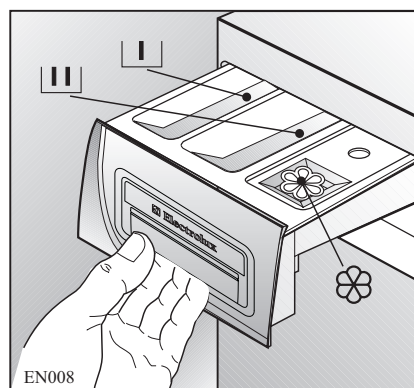

# Control panel

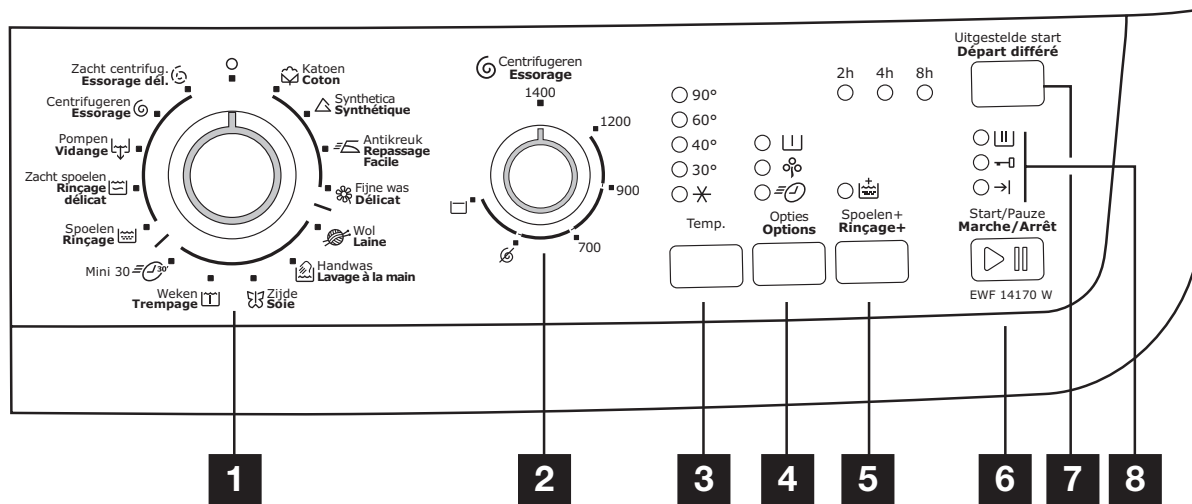

- 1** Programme selector dial
- 2** Spin selector dial
- 3** Temperature button
- 4** Options button
- 5** Extra Rinse button
- 6** Start/Pause button
- 7** Delay Start button
- 8** Programme progress display



## Use

### First Use



- Ensure that the electrical and water connections comply with the installation instructions.
- Remove the polystyrene block and any material from the drum.
- Pour 2 litres of water into the main wash compartment  of the detergent drawer in order to activate the ECO valve. Then run a cotton cycle at 90°C, without any laundry in the machine, to remove any manufacturing residue from the drum and tub. Pour 1/2 a measure of detergent into the dispenser drawer and start the machine.

### Daily Use



#### Load the laundry



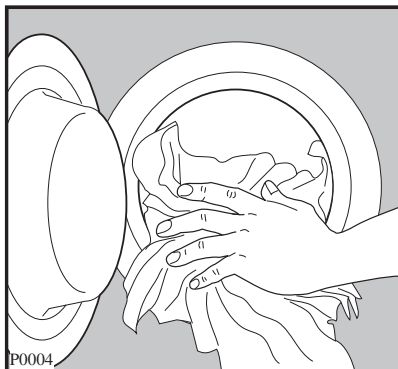

Open the door by carefully pulling the door handle outwards. Place the laundry in the drum, one item at a time, shaking them out as much as possible. Close the door.

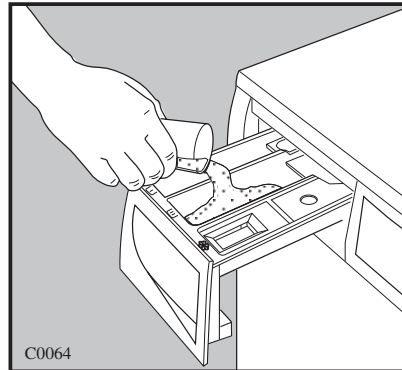

#### Measure out the detergent and the fabric softener

Pull out the dispenser drawer until it stops. Measure out the amount of detergent required, pour it into the main wash compartment  and, if you wish to carry out the “**prewash**” or soak  phase, pour it into the compartment marked .



If required, pour fabric softener into the compartment marked  (the amount used must not exceed the “MAX” mark in the drawer). Close the drawer gently.

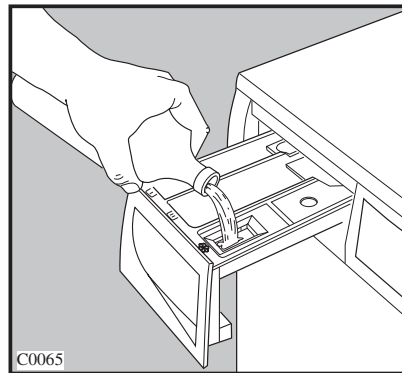

### Select the required programme

Turn the programme selector dial to the required programme.

The green Start/Pause light starts to flash.

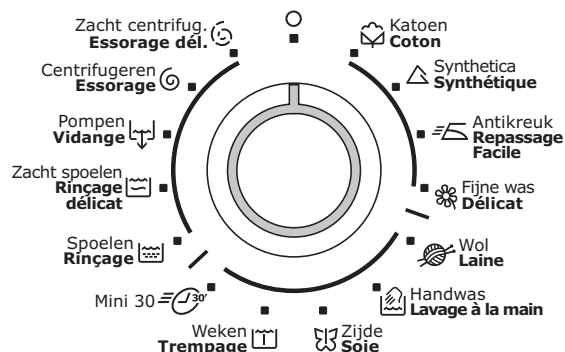

The selector dial is divided into following sections:

- Cottons
- Synthetics
- Delicates
- Special programmes: Wool and Handwash , Silk , Soak , Mini 30 , Rinses , Delicate Rinses , Drain , Spin , Delicate spin

The selector dial can be turned either clockwise or anticlockwise. Position **O** to Reset programme/Switching OFF of the machine.

**At the end of the programme the selector dial must be turned to position O, to switch the machine off.**

#### Attention!

If you turn the programme selector dial to another programme when the machine is working, the **red** Start/Pause pilot light will flash 3 times to indicate a wrong selection. The machine will not perform the new selected programme.

### Select the required temperature

Turn the temperature selector dial to select the washing temperature.

Maximum temperatures are 90°C for cottons, 60° for synthetic fabrics and easy iron, 40°C for delicates, wool and fabrics to be hand-washed, 30°C for silk, mini 30 and soak.

By selecting position (Cold) the machine will wash with cold water. To be used for extremely delicate items, such as curtains.

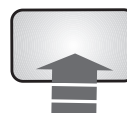
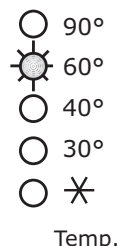

### Programme Option buttons

Depending on the programme, different functions can be combined. These must be selected after choosing the desired programme and before depressing the Start/Pause button.

When these buttons are pressed, the corresponding pilot lights come on. When they are pressed again, the pilot lights go out.

### Select the Spin Speed, No Spin or Rinse Hold

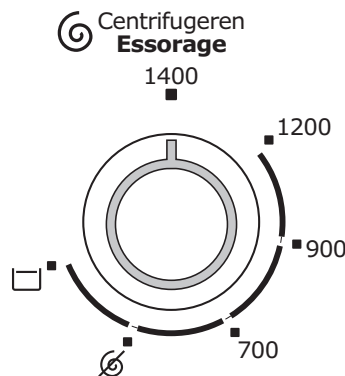





Turn the Spin selector to change the spin speed, if you want your laundry to be spun at a speed different from the one proposed by the washing machine. The relevant light will light up.





Maximum speeds are:

- for cotton: 1400 rpm;
- for synthetics, easy iron, wool and handwash: 900 rpm,
- for delicate fabrics, silk, mini 30: 700 rpm.

**No spin** : by selecting this option, the appliance will not spin the laundry. As all spinning phases are suppressed, on cotton, synthetic and delicate programmes the rinses will be performed with more water.

**Rinse Hold** : by selecting this option the water of the last rinse is not emptied out to prevent the fabrics from creasing. When the programme has finished the pilot lights  (End) and  (Door) are on, the Start/Pause light and “wash”  pilot light are off and the door is locked to indicate that the water must be emptied out.

#### To empty out the water:

- turn the programme selector dial to “O”
- select the  (Drain),  (Spin) or  (Delicate spin) programme
- reduce the spin speed if needed, by means of the relevant selector
- depress Start/Pause button
- at the end of programme, only the pilot lights  (End) comes on.

## Select the Prewash, Economy or Super Quick option

You can select 3 different options. The relevant light will light up.

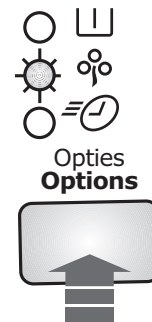

** Prewash:** select this option if you wish your laundry to be prewashed at 30°C before the main wash. This option is not available with the wool, handwash, silk and mini programmes. The prewash ends with a short spin in programmes for cotton and synthetic fabrics, whereas in the programmes for delicate fabrics the water is only drained.

** Economy:** to be used for lightly or normally soiled cotton or synthetic items. The washing time will be prolonged and the temperature reduced according to the type of fabric .

** Super quick:** a very short cycle for very slightly items that have been used or worn for a short time. The max load has to be reduced. These options **cannot** be selected together.

## Select the Extra Rinse option





This option is recommended for people who are allergic to detergents, and in areas where the water is very soft. This button can be selected with all programmes except the silk, wool and hand wash programmes. The machine performs some additional rinses.

## Select the Start/Pause



To start the selected programme, press the **“Start/Pause”** button; the corresponding green pilot light stops flashing.

The **“wash”**  and **“door”**  lights are on to indicate that the appliance starts operating and the door is locked. To interrupt a programme which is running, depress the **“Start/Pause”** button: the corresponding green pilot light starts to flash.

To restart the programme from the point at which it was interrupted, **press** the “start/pause” **button again**.

If you have chosen a delayed start, the machine will begin the countdown.

If an incorrect option is selected, an integrated **red** pilot light of the “Start/Pause” button flashes for 3 times.

## Select the Delay start

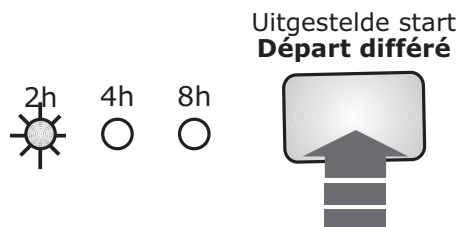

**Before you start the programme**, if you wish to delay the start, press the Delay Start button repeatedly, to select the desired delay. The relevant light illuminates.

This button makes it possible to delay the starting of the washing programme by 2, 4, and 8 hours.

You must select this option after you have set the programme and before you press the Start/Pause button. You can cancel the delay time at any moment, before you press the Start/Pause button.

If you have already pressed the Start/Pause button, and you wish to cancel the delay time, proceed as follows:

- set the washing machine to PAUSE by pressing the Start/Pause button;
- press the Delay Start button once, the light relevant to the selected delay goes off.
- press the Start/Pause button again to start the programme.

### Important!

- The selected delay can be changed only after selecting the washing programme again.

- The door will be locked throughout the delay time. If you need to open the door, you must first set the washing machine to PAUSE by pressing the Start/Pause button and then wait about 2 minutes. After you have closed the door, press the Start/Pause button again.

The Delay Start can not be selected with **Drain** ↕ programme.

### Programme progress display

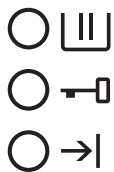

After having pressed the Start/Pause button, the **“wash”** ||| pilot lights comes on.

When the pilot light “wash” comes on this means that the machine is performing the washing cycle. If you have selected the **“prewash”** | pilot function, this light will be on during the prewash phase too.

The **“door”** →| pilot light indicates if the door can be opened:

- on: the door cannot be opened.  
The appliance is running.
- light off: the door can be opened.  
The washing programme is finished.
- flashing light: the door is opening.

When the programme has finished, the **“End”** →| pilot light comes on.

### Altering an option or a running programme

It is possible to change any option before the programme carries it out. Before you make any change, you must pause the washing machine by pressing the **“Start/Pause”** button.

Changing a running programme is possible **only by resetting it**. Turn the programme selector dial to **“O”** and then to the new programme position. Start the new programme by depressing the **“Start/Pause”** button again. The washing water in the tub will not emptied out.

### Interrupting a programme

Depress the **“Start/Pause”** button to interrupt a programme which is running, the corresponding light starts to flash. Depress the button again to restart the programme.

### Cancelling a programme

Turn the selector dial to **“O”** to cancel a programme which is running. Now you can select a new programme.

### Opening the door after the programme has started



First set the machine to pause by pressing the **“Start/Pause”** button. If the **“door”**  light flashes and after 2 minutes goes off, the door can be opened.



If the **“door”**  light does not switch off, this means that the machine is already heating, that the water level is above the bottom edge of the door or that the drum is turning.

In this case the door can not be opened.

If you cannot open the door but you need to open it you have to switch the machine off by turning the selector dial to **“O”**. After about 2 minutes the door can be opened (**pay attention to the water level and temperature!**).

### At the end of the programme

The machine stops automatically. The phase light **“end”**  illuminates, **“wash”** , **“door”**  and the **“Start/Pause”** light go off and the door could be opened.

If the **Rinse Hold**  option has been selected, the phase lights **“end”**  and **“door”**  illuminate, the **“Start/Pause”** light goes off and the door remains locked to indicate that the water must be emptied out before opening the door.

### To empty out the water please read the steps on the Rinse Hold option paragraph.

Turn the programme selector dial to **“O”** to switch the machine off. Remove the laundry from the drum and carefully check that the drum is empty.

If you do not intend to carry out another wash, close the water tap. Leave the door open to prevent the formation of mildew and unpleasant smells.

## Washing hints



### Sorting the laundry

Follow the wash code symbols on each garment label and the manufacturer's washing instructions. Sort the laundry as follows: whites, coloureds, synthetics, delicates, woollens.

### Temperatures

90°/95°	for normally soiled white cottons and linen (e.g. tea cloths, towels, tablecloths, sheets...)
50°-60°	for normally soiled, colour fast garments (e.g. shirts, night dresses, pyjamas...) in linen, cotton or synthetic fibres and for lightly soiled white cotton (e.g. underwear).
30°-40° ✱	for delicate items (e.g. net curtains), mixed laundry including synthetic fibres and woollens bearing the label «pure new wool, machine washable, non-shrink».

### Before loading the laundry

Never wash whites and coloureds together. Whites may lose their "whiteness" in the wash.

New coloured items may run in the first wash; they should therefore be washed separately the first time.

### Make sure that no metal objects are left in the laundry (e.g. hair clips, safety pins, pins).

Button up pillowcases, close zip fasteners, hooks and poppers. Tie any belts or long tapes.

Remove persistent stains before washing.

Rub particularly soiled areas with a special detergent or detergent paste. Treat curtains with special care. Remove hooks or tie them up in a bag or net.

### Maximum loads

Recommended loads are indicated in the programme charts.

General rules:

**Cotton, linen:** drum full but not too tightly packed;

**Synthetics:** drum no more than half full;

**Delicate fabrics and woollens:** drum no more than one third full.

Washing a maximum load makes the most efficient use of water and energy.

For heavily soiled laundry, reduce the load size.

### Laundry weights

The following weights are indicative:

bathrobe	1200 g
napkin	100 g
quilt cover	700 g
sheet	500 g
pillow case	200 g
tablecloth	250 g
towelling towel	200 g
tea cloth	100 g
night dress	200 g
ladies' briefs	100 g
man's work shirt	600 g
man's shirt	200 g
man's pyjamas	500 g
blouse	100 g
men's underpants	100 g

### Removing stains

Stubborn stains may not be removed by just water and detergent. It is therefore advisable to treat them prior to washing.

**Blood:** treat fresh stains with cold water. For dried stains, soak overnight in water with a special detergent then rub in the soap and water.

**Oil based paint:** moisten with benzine stain remover, lay the garment on a soft cloth and dab the stain; treat several times.

**Dried grease stains:** moisten with turpentine, lay the garment on a soft surface and dab the stain with the fingertips and a cotton cloth.

**Rust:** oxalic acid dissolved in hot water or a rust removing product used cold. Be careful with rust stains which are not recent since the cellulose structure will already have been damaged and the fabric tends to hole.

**Mould stains:** treat with bleach, rinse well (whites and fast coloureds only).

**Grass:** soap lightly and treat with bleach (whites and fast coloureds only).

**Ball point pen and glue:** moisten with acetone (\*), lay the garment on a soft cloth and dab the stain.

**Lipstick:** moisten with acetone as above, then treat stains with methylated spirits. Remove any residual marks from white fabrics with bleach.

Red wine: soak in water and detergent, rinse and treat with acetic or citric acid, then rinse. Treat any residual marks with bleach.

**Ink:** depending on the type of ink, moisten the fabric first with acetone (\*), then with acetic acid; treat any residual marks on white fabrics with bleach and then rinse thoroughly.

**Tar stains:** first treat with stain remover, methylated spirits or benzine, then rub with detergent paste.

(\*) do not use acetone on artificial silk.

## Detergents and additives

Good washing results also depend on the choice of detergent and use of the correct quantities to avoid waste and protect the environment. Although biodegradable, detergents contain substances which, in large quantities, can upset the delicate balance of nature.

The choice of detergent will depend on the type of fabric (delicates, woollens, cottons, etc.), the colour, washing temperature and degree of soiling.

All commonly available washing machine detergents may be used in this appliance:

- powder detergents for all types of fabric,
- powder detergents for delicate fabrics (60°C max) and woollens,
- liquid detergents, preferably for low temperature wash programmes (60°C max) for all types of fabric, or special for woollens only.

The detergent and any additives must be placed in the appropriate compartments of the dispenser drawer before starting the wash programme.

If using concentrated powder or liquid detergents, a programme **without** prewash must be selected.

The washing machine incorporates a recirculation system which allows an optimal use of the concentrated detergent.

Pour liquid detergent into the dispenser drawer compartment marked  **just before** starting the programme.

Any fabric softener or starching additives must be poured into the compartment marked  before starting the wash programme.



Follow the product manufacturer's recommendations on quantities to use and **do not exceed the «MAX» mark in the detergent dispenser drawer.**

### Quantity of detergent to be used

The type and quantity of detergent will depend on the type of fabric, load size, degree of soiling and hardness of the water used.

Water hardness is classified in so-called "degrees" of hardness. Information on hardness of the water in your area can be obtained from the relevant water supply company, or from your local authority.

Follow the product manufacturers' instructions on quantities to use.













Use less detergent if:



- you are washing a small load,
- the laundry is lightly soiled,
- large amounts of foam form during washing.





Degrees of water hardness			
Level	Characteristic	Degrees	
		German °dH	French °T.H.
1	soft	0-7	0-15
2	medium	8-14	16-25
3	hard	15-21	26-37
4	very hard	> 21	> 37





**i** **International wash code symbols**







These symbols appear on fabric labels, in order to help you choose the best way to treat your laundry.

<b>Energetic wash</b>   <b>Delicate wash</b>	 Max. wash temperature 95°C	 Max. wash temperature 60°C	 Max. wash temperature 40°C	 Max. wash temperature 30°C	 Hand wash	 Do not wash at all
	 Max. wash temperature 60°C	  Max. wash temperature 40°C	 Max. wash temperature 30°C			





















 <b>Bleaching</b>	 Bleach in cold water	 Do not bleach
---	---	--

 <b>Ironing</b>	 Hot iron max 200°C	 Warm iron max 150°C	 Lukewarm iron max 110°C	 Do not iron
---	---	--	--	--















 <b>Dry cleaning</b>	 Dry cleaning in all solvents	 Dry cleaning in perchlorethylene, petrol, pure alcohol, R 111 & R 113	 Dry cleaning in petrol, pure alcohol and R 113	 Do not dry clean
--	---	--	---	---

 <b>Drying</b>	 Flat	 On the line	 On clothes hanger	 high temperature  low temperature Tumble dry	 Do not tumble dry
--	---	--	--	---	--

## Washing programmes

Programme/ Temperature	Type of laundry	Options	Description of programme
 Cottons  -90°	<b>White and coloureds cotton:</b> e.g. sheets, tablecloths, household linen.	Spin red./ <input type="checkbox"/> /No spin Prewash, Economy, Super Quick, 	Main wash 3 rinses Long spin
 Cottons +  Economy 40°-90°	<b>White and coloured cotton economy,</b> lightly soiled items, shirts, blouses, underwear.	Spin red./ <input type="checkbox"/> /No spin Economy, 	Main wash 2 rinses Long spin
 Synthetics  -60°	<b>Synthetic or mixed fabrics,</b> underwear, coloured garments, non-shrink shirts, blouses.	Spin red./ <input type="checkbox"/> /No spin Prewash, Economy, Super Quick, 	Main wash 3 rinses Short spin
 Easy Iron  -60°	Synthetics to be gentle washed and spun.	Spin red./ <input type="checkbox"/> /No spin Prewash 	Main wash 4 rinses Short spin
 Delicates  -40°	<b>Delicate fabrics,</b> for example curtains	<input type="checkbox"/> /No spin Prewash, Super Quick, 	Main wash 3 rinses Short spin
 Wool  -40°	Specially tested programme for wool garments bearing the "Pure new wool, non-shrink, machine washable" label.	Spin red./ <input type="checkbox"/> /No spin	Main wash from 40°C to  (cold) 3 rinses Short spin
 Handwash  -40°	Special programme for hand washing fabrics	Spin red./ <input type="checkbox"/> /No spin	Main wash from 40°C to  (cold) 3 rinses Short spin

## Washing programmes

Programme/ Temperature	Type of laundry	Options	Description of programme
Silk  30°	Special programme for silk items	 /No spin	Main wash 3 rinses Short spin
Soak  30°	Separate soak programme for heavily soiled items		Soak at 30°C, for 20 min.
Mini 30° 	Separate short programme for lightly soiled synthetic, mixed fabrics and delicates	No spin	Main wash 2 rinses Short spin
Rinse 	Separate rinse cycle for hand washed items of cottons.	Spin red./  /No spin 	3 rinses Long spin
Delicate rinses 	Separate rinse cycle for hand washed items of synthetics, delicates, wool, and silk.	 /No spin 	3 rinses Short spin
Drain 	For emptying out the last rinse water in programmes with the Rinse Hold option or Soak programme.		Draining of water
Spin 	Separate spin for cotton fabrics	Spin red.	Drain and long spin
Delicate spin 	Separate spin for synthetic, delicate, wool, handwash and silk fabrics.		Drain and short spin
	For cancelling the wash programme which is running and for switching the machine off.		





Max. Cottons load .....6 kg.  
 Max. Synthetics/Delicates load.....3 kg.  
 Max. Wool and Handwash load .....2 kg.

Max. Silk load .....1 kg.  
 Max. Soak load .....6 kg.  
 Max. Mini-programme load .....3 kg.

## Programme information



### Wool and Handwash

Washing programme for machine washable wool  as well as for hand washable woollens and delicate fabrics with the “hand washing” care symbol .



### Easy Iron

Selecting this programme the laundry is gently washed and spun to avoid any creasing. In this way ironing is easier. Furthermore the machine will perform additional rinses. The maximum load is 1,5 kg.



### Silk

With this programme it is possible to wash silk items. The maximum spin speed is automatically reduced to 700 rpm.





### Rinses

With this programme it is possible to rinse and spin cotton garments which have been washed by hand. The machine performs 3 rinses, followed by a final spin at maximum speed. The spin speed can be reduced by turning the spin selector.



### Drain

For emptying out the water of the last rinse in programmes with the Rinse Hold  option or Soak programme. Turn first the programme selector dial to **0**, then select programme  Drain and depress the Start/Pause button.



### Spin/Delicate

Separate spin for hand washed garments and after programmes with Rinse Hold  option or Soak programme. option. Before selecting this programme the selector dial must be turned to **0**. You can choose the speed by means of the relevant selector to adapt it to the fabrics to be spun.



### Mini 30°

This is a complete programme to be used for lightly soiled laundry or for laundry which needs freshing up (not available for wool and handwash). Washing temperature 30° C, programme duration 30 min.



### Soak

Soak lasts for about 20 minutes at 30°C. At the end of the soak time the machine will stop automatically with water left in the tub. For emptying out the water of the last rinse, turn first the programme selector dial to **0**, then select programme  Drain and depress the Start/Pause button.

## Care and cleaning



You must **DISCONNECT** the appliance from the electricity supply, before you can carry out any cleaning or maintenance work.

### Descaling

The water we use normally contains lime. It is a good idea to periodically use a water softening powder in the machine. Do this separately from any laundry washing, and according to the softening powder manufacturer's instructions. This will help to prevent the formation of lime deposits.

### After each wash

Leave the door open for a while. This helps to prevent mould and stagnant smells forming inside the appliance. Keeping the door open after a wash will also help to preserve the door seal.

### Maintenance Wash

With the use of low temperature washes it is possible to get a build up of residues inside the drum.

We recommend that a maintenance wash be performed on a regular basis.

To run a maintenance wash:

- The drum should be empty of laundry.
- Select the hottest cotton wash programme.
- Use a normal measure of detergent, must be a powder with biological properties.

### External cleaning

Clean the exterior cabinet of the appliance with soap and water only, and then dry thoroughly.

### Cleaning the dispenser drawer

The washing powder and additive dispenser drawer should be cleaned regularly.

Remove the drawer by pressing the catch downwards and by pulling it out. Flush it out under a tap, to remove any traces of accumulated powder.

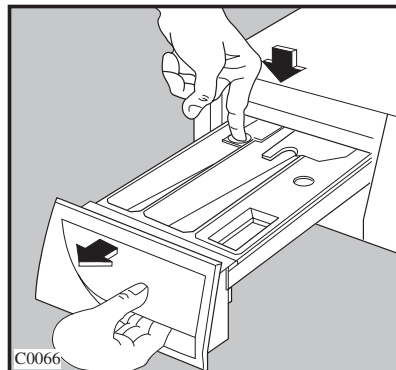

To aid cleaning, the top part of the additive compartment should be removed.

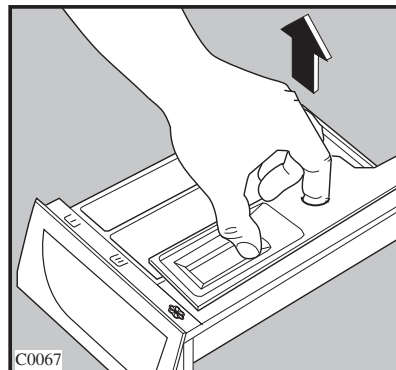

### Cleaning the drawer recess

Having removed the drawer, use a small brush to clean the recess, ensuring that all washing powder residue is removed from the upper and lower part of the recess.

Replace the drawer and run the rinse programme without any clothes in the drum.

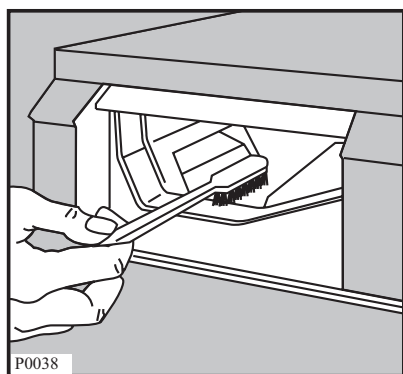

### Cleaning the pump

The pump should be inspected if

- the machine does not empty and/or spin
- the machine makes an unusual noise during draining due to objects such as safety pins, coins etc. blocking the pump.

Proceed as follows:

- Disconnect the appliance.
- If necessary wait until the water has cooled down.
- Open the pump door.

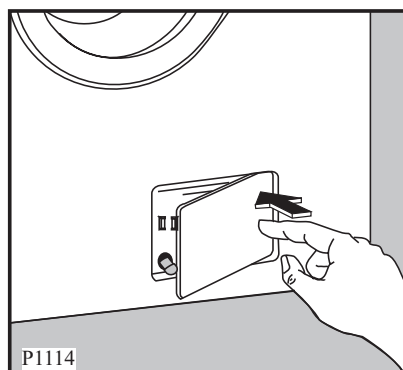

- Place a container close to the pump to collect any spillage.
- Pull out the emergency emptying hose, place it in the container and remove its cap.
- When no more water comes out, unscrew the pump cover and remove it. Always keep a rag nearby to dry up spillage of water when removing the cover.

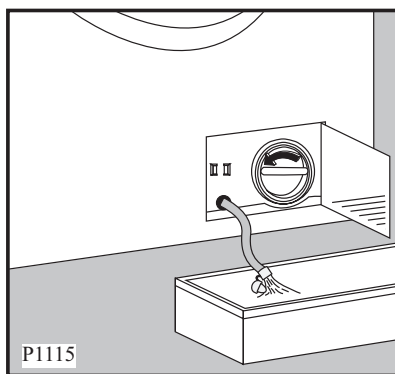

- Remove any objects from the pump impeller by rotating it.

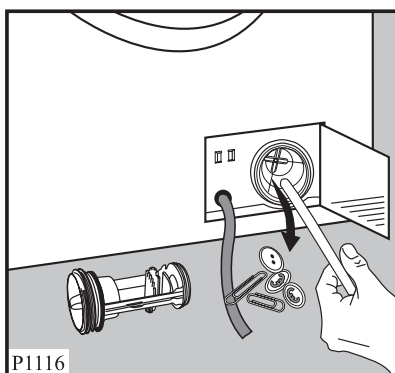

- Put the cap back on the emergency emptying hose and place the latter back in its seat.

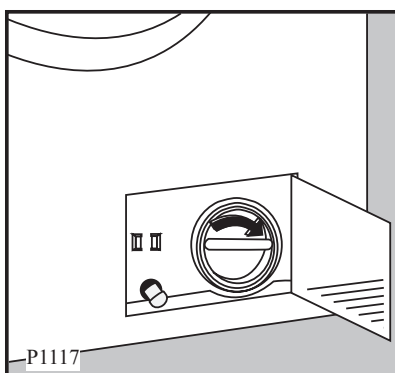

- Screw the pump cover fully in.
- Close the pump door.



### Warning!

When the appliance is in use and depending on the programme selected there can be hot water in the pump.

Never remove the pump cover during a wash cycle, always wait until the appliance has finished the cycle, and is empty. When replacing the cover, ensure it is securely retightened so as to stop leaks and young children being able to remove it.

### **Cleaning the water inlet filter**

If your water is very hard or contains traces of lime deposit, the water inlet filter may become clogged.

It is therefore a good idea to clean it from time to time.

Turn off the water tap. Unscrew the water inlet hose. Clean the filter using a hard bristle brush. Tighten up the inlet hose.

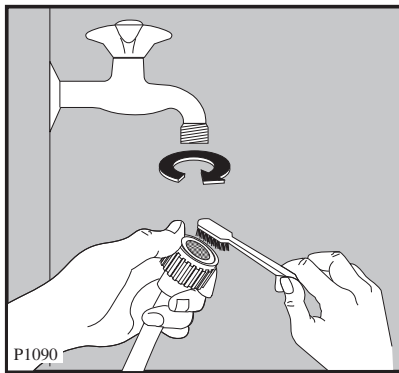

### **The dangers of freezing**

If the machine is exposed to temperatures below 0°C, certain precautions should be taken.

- Turn off the water tap.
- Unscrew the inlet hose.
- Place the end of the emergency emptying hose and that of the inlet hose in a bowl placed on the floor and let water drain out.
- Screw the water inlet hose back on and reposition the emergency emptying hose after having put the cap on again.
- When you intend to start the machine up again, make sure that the room temperature is above 0°C.



### **Important!**

Every time you drain the water through the emergency emptying hose you must pour 2 litres of water into the main wash compartment of the detergent drawer and then run the drain programme. This will activate the ECO VALVE device avoiding that part of the detergent remains unused at next washing.

### **Emergency emptying out**

If the water is not discharged, proceed as follows to empty out the machine:

- pull out the plug from the power socket;
- close the water tap;
- if necessary, wait until the water has cooled down;
- open the pump door;
- place a bowl on the floor and place the end of the emergency emptying hose into the bowl. Remove its cap. The water should drain by gravity into the bowl. When the bowl is full, put the cap back on the hose. Empty the bowl. Repeat the procedure until water stops flowing out;
- clean the pump if necessary as previously described;
- replace the emergency emptying hose in its seat after having plugged it;
- screw the pump cover again and close the door.



## Something not working

Certain problems are due to lack of simple maintenance or oversights, which can be solved easily without calling out an engineer. Before contacting your local Service Centre, please carry out the checks listed below.

During machine operation it is possible that the **red** Start/Pause pilot light flashes to indicate that the machine is not working.

Once the problem has been eliminated, press the **Start/Pause** button to restart the programme. If after all checks, the problem persists, contact your local Service Centre.

Malfunction	Possible cause	Solution
The washing machine does not start:	<ul style="list-style-type: none"> <li>● The door has not been closed. <b>(Red Start/Pause pilot light flashes)</b>.</li> <li>● The plug is not properly inserted in the power socket.</li> <li>● There is no power at the socket.</li> <li>● The main fuse has blown.</li> <li>● The selector dial is not correctly positioned and the Start/Pause button has not been depressed.</li> <li>● The delay start has been selected.</li> </ul>	<ul style="list-style-type: none"> <li>● Close firmly the door.</li> <li>● Insert the plug into the power socket.</li> <li>● Please check your domestic electrical installation.</li> <li>● Replace the fuse.</li> <li>● Please turn the selector dial and press the Start/Pause button again.</li> <li>● If the laundry are to be washed immediately, cancel the delay start.</li> </ul>
The machine does not fill:	<ul style="list-style-type: none"> <li>● The water tap is closed. <b>(Red Start/Pause pilot light flashes)</b></li> <li>● The inlet hose is squashed or kinked. <b>(Red Start/Pause pilot light flashes)</b></li> <li>● The filter in the inlet hose is blocked. <b>(Red Start/Pause pilot light flashes)</b></li> <li>● The door is not properly closed. <b>(Red Start/Pause pilot light flashes)</b></li> </ul>	<ul style="list-style-type: none"> <li>● Open the water tap.</li> <li>● Check the inlet hose connection.</li> <li>● Clean the water inlet hose filter.</li> <li>● Close firmly the door.</li> </ul>
The machine fills then empties immediately:	<ul style="list-style-type: none"> <li>● The end of the drain hose is too low.</li> </ul>	<ul style="list-style-type: none"> <li>● Refer to relevant paragraph in “water drainage” section.</li> </ul>

Malfunction	Possible cause	Solution
The machine does not empty and/or does not spin:	<ul style="list-style-type: none"> <li>● The drain hose is squashed or kinked. <b>(Red Start/Pause pilot light flashes)</b></li> <li>● The drain pump is clogged. <b>(Red Start/Pause pilot light flashes)</b></li> <li>● The Rinse hold, No spin option or Soak programme has been selected.</li> <li>● The laundry is not evenly distributed in the drum.</li> </ul>	<ul style="list-style-type: none"> <li>● Check the drain hose connection.</li> <li>● Clean the drain pump.</li> <li>● Drain the water.</li> <li>● Redistribute the laundry.</li> </ul>
There is water on the floor:	<ul style="list-style-type: none"> <li>● Too much detergent or unsuitable detergent (creates too much foam) has been used.</li> <li>● Check whether there are any leaks from one of the inlet hose fittings. It is not always easy to see this as the water runs down the hose; check to see if it is damp.</li> <li>● The drain hose is damaged.</li> <li>● The cap on the emergency emptying hose has not been replaced after cleaning the pump.</li> </ul>	<ul style="list-style-type: none"> <li>● Reduce the detergent quantity or use another one.</li> <li>● Check the water inlet hose connection.</li> <li>● Change it with a new one.</li> <li>● Put the cap back on the emergency emptying and place the latter back in its seat.</li> </ul>
Unsatisfactory washing results:	<ul style="list-style-type: none"> <li>● Too little detergent or unsuitable detergent has been used.</li> <li>● Stubborn stains have not been treated prior to washing.</li> <li>● The correct temperature was not selected.</li> <li>● Excessive laundry load.</li> </ul>	<ul style="list-style-type: none"> <li>● Increase the detergent quantity or use another one.</li> <li>● Use commercial products to treat the stubborn stains.</li> <li>● Check if you have selected the correct temperature.</li> <li>● Introduce into the drum less laundry.</li> </ul>
The door will not open:	<ul style="list-style-type: none"> <li>● The programme is still running.</li> <li>● The door lock has not been released.</li> <li>● There is water in the drum.</li> </ul>	<ul style="list-style-type: none"> <li>● Wait the end of washing cycle.</li> <li>● Wait about 2 minute.</li> <li>● Select drain or spin programme to empty out the water.</li> </ul>

Malfunction	Possible cause	Solution
The machine vibrates or is noisy:	<ul style="list-style-type: none"> <li>● The transit bolts and packing have not been removed.</li> <li>● The support feet have not been adjusted.</li> <li>● The laundry is not evenly distributed in the drum.</li> <li>● Maybe there is very little laundry in the drum.</li> </ul>	<ul style="list-style-type: none"> <li>● Check the correct installation of the appliance.</li> <li>● Check the correct levelling of the appliance.</li> <li>● Redistribute the laundry.</li> <li>● Load more laundry.</li> </ul>
Spinning starts late or the machine does not spin:	<ul style="list-style-type: none"> <li>● The electronic unbalance detection device has cut in because the laundry is not evenly distributed in the drum. The laundry is redistributed by reverse rotation of the drum. This may happen several times before the unbalance disappears and normal spinning can resume. If, after 10 minutes, the laundry is still not evenly distributed in the drum, the machine will not spin. In this case, redistribute the load manually and select the spin programme.</li> </ul>	<ul style="list-style-type: none"> <li>● Redistribute the laundry.</li> </ul>
The machine makes an unusual noise	<ul style="list-style-type: none"> <li>● The machine is fitted with a type of motor which makes an unusual noise compared with other traditional motors. This new motor ensures a softer start and more even distribution of the laundry in the drum when spinning, as well as increased stability of the machine.</li> </ul>	
No water is visible in the drum	<ul style="list-style-type: none"> <li>● Machines based on modern technology operate very economically using very little water without affecting performance.</li> </ul>	

**28** electrolux **something not working**

If you are unable to identify or solve the problem, contact our service centre. Before telephoning, make a note of the model, serial number and purchase date of your machine: the Service Centre will require this information.

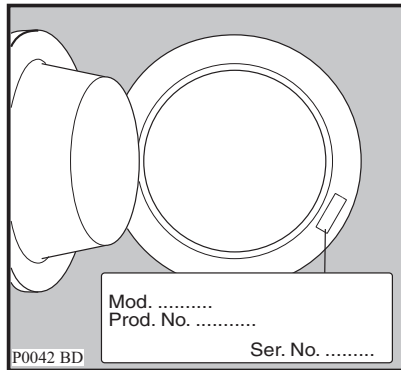

## Technical data

Dimensions	Width	60 cm
	Height	85 cm
	Depth	59 cm
Electrical connection Voltage - Overall power - Fuse	Information on the electrical connection is given on the rating plate on the inner edge of the appliance door	
Water supply pressure	Minimum	0,05 MPa
	Maximum	0,8 MPa
Maximum Load	Cotton	6 kg
	Synthetics/Delicates	3 kg
	Easy iron	1,5 kg
	Woollens and handwash	2 kg
	Silk	1 kg
Spin Speed	Maximum	1400 rpm



Consumption values			
Programme	Programme duration (in minutes)	Energy consumption (in kWh)	Water consumption (in litres)
Cottons 90°	135	2.0	61
Cottons Economy 60°(*)	145	1.02	46
Synthetics 60°	90	1.0	54
Easy Iron 40°	90	0.35	60
Delicates 40°	65	0.55	60
Wool 40°	60	0.4	53
Handwash 40°	60	0.4	53
Silk 30°	30	0.2	47
Soak 30°	45	0.4	19
Mini 30°	30	0.28	57
Rinses	45	0.1	42
Delicate rinses	30	0.05	50
Drain	2	-	-
Spin	10	-	-
Delicate spin	6	-	-



(\*) “Cottons 60°+ Economy” is the reference programme for the data entered in the energy label, in compliance with EEC 92/75 standards.

The consumption data shown on this chart is to be considered purely indicative, as it may vary depending on the quantity and type of laundry, on the inlet water temperature and on the ambient temperature. It refers to the highest temperature for each wash programme.

# Installation

## Unpacking



All transit bolts and packing must be removed before using the appliance. You are advised to keep all transit devices so that they can be refitted if the machine ever has to be transported again.

1. After removing all the packaging, carefully lay machine on it's back to remove the polystyrene base from the bottom.

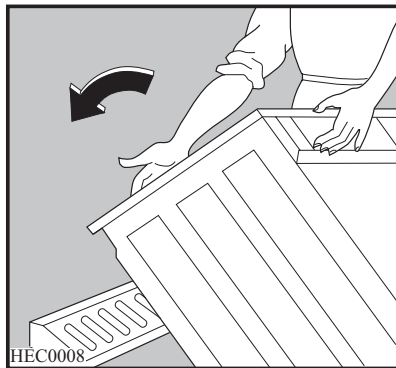

2. Remove the power supply cable and the draining hose from the hose holders on the rear of the appliance.

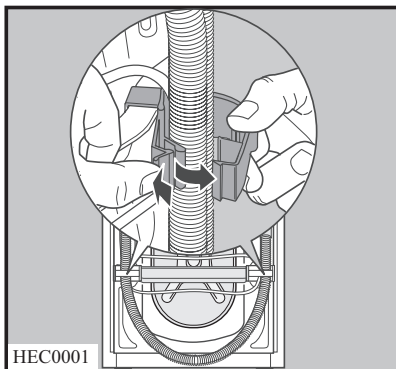

3. With a suitable spanner unscrew and remove the central rear bolt **A**. Slide out the relevant plastic spacer.

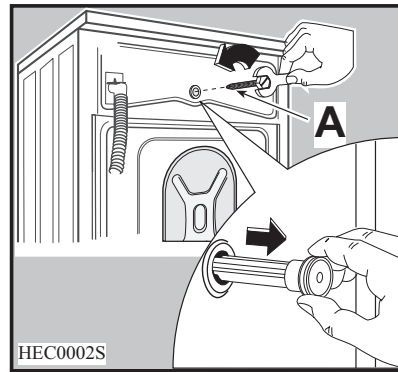

4. Unscrew and remove the two large rear bolts **B** and the six smaller bolts **C**.

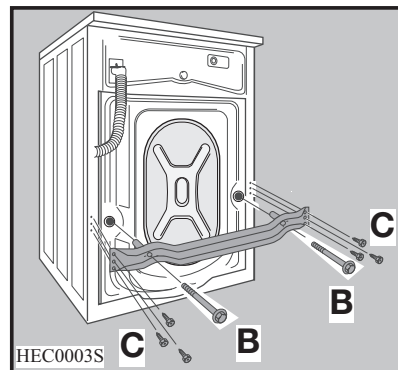

5. Remove the bracket **D** and tighten up the six smaller bolts **C**.

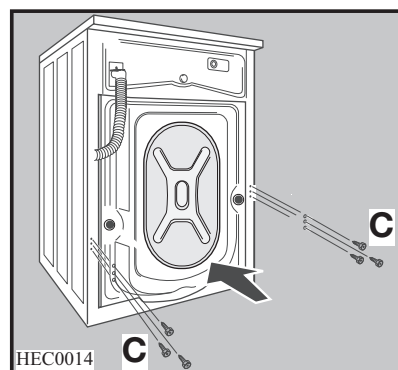
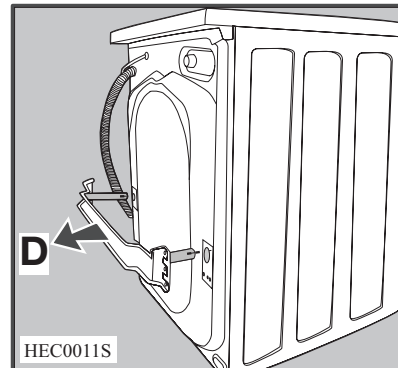

- Open the porthole, take out the inlet hose from the drum and remove the polystyrene block fitted with the adhesive tape on the door seal.

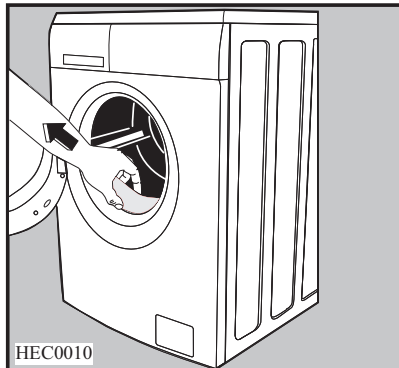

- Fill the smaller upper hole and the two large ones with the corresponding plastic plug caps supplied in the bag containing the instruction booklet.

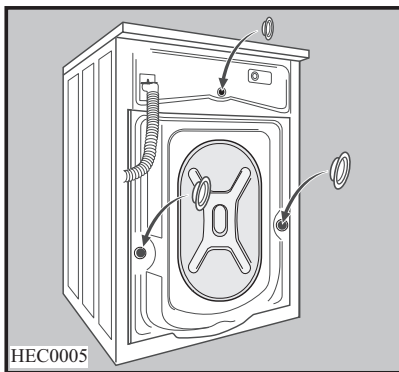

### Positioning

Install the machine on a flat hard floor. Make sure that air circulation around the machine is not impeded by carpets, rugs etc. Check that the machine does not touch the wall or other kitchen units. Level the washing machine by raising or lowering the feet. The feet may be tight to adjust as they incorporate a self locking nut, but the machine **MUST** be level and stable.

If necessary, check the setting with a spirit level.

Any necessary adjustment can be made with a spanner.

Accurate levelling prevents vibration, noise and displacement of the machine during operation. Never place cardboard, wood or similar materials under the machine to compensate for any unevenness in the floor.

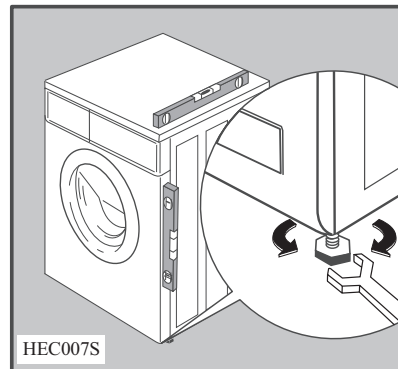

### Water inlet

An inlet hose is supplied and can be found inside the machine drum. Do not use already employed hoses for water connections.

- Open the porthole and extract the inlet hose.
- Connect the hose with the angled connection to the machine.



**Do not place the inlet hose downwards. Angle the hose to the left or right depending on the position of your water tap.**

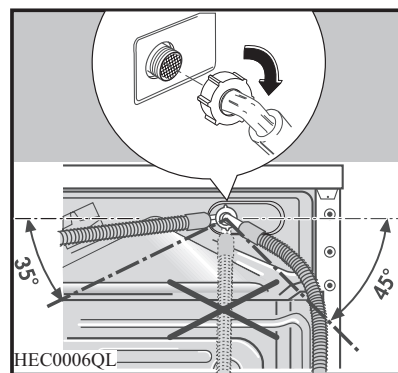

- Set the hose correctly by loosening the ring nut.



After positioning the inlet hose, be sure to tighten the ring nut again to prevent leaks.

4. Connect the hose to a tap with a 3/4" thread. Always use the hose supplied with the appliance. The inlet hose must not be lengthened. If it is too short and you do not wish to move the tap, you will have to purchase a new, longer hose specially designed for this type of use.

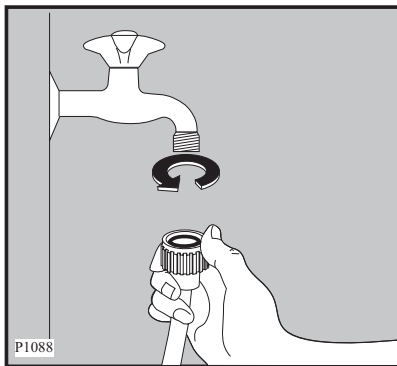

The inlet hose must not be lengthened. If it is too short and you do not wish to move the tap, you will have to purchase a new, longer hose specially designed for this type of use.

### Water drainage

The end of the drain hose can be positioned in three ways:

**Hooked over the edge of a sink using the plastic hose guide supplied with the machine.** In this case, make sure the end cannot come unhooked when the machine is emptying. This could be done by tying it to the tap with a piece of string or attaching it to the wall.

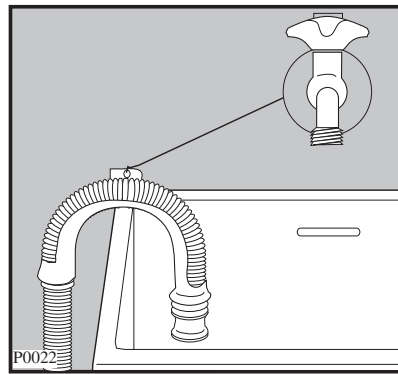

**In a sink drain pipe branch.** This branch must be above the trap so that the bend is at least 60 cm above the ground.

**Directly into a drain pipe at a height** of not less than 60 cm and not more than 90 cm. The end of the drain hose must always be **ventilated**, i.e. the inside diameter of the drain pipe must be larger than the outside diameter of the drain hose.

The drain hose must not be kinked.

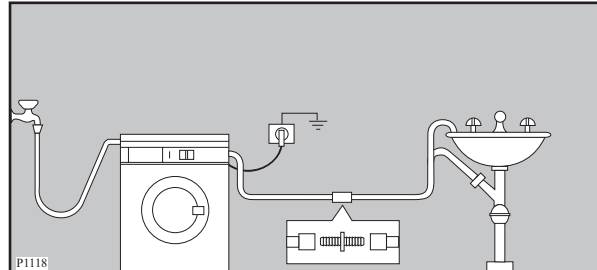

The drain hose may be extended to a maximum of 4 metres. An additional drain hose and joining piece is available from your local Service Centre.

## **Electrical connection**

This machine is designed to operate on a 220-230 V, single-phase, 50 Hz supply.

Check that your domestic electrical installation can take the maximum load required (2.2 kW), also taking into account any other appliances in use.

### **Connect the machine to an earthed socket.**



The manufacturer declines any responsibility for damage or injury through failure to comply with the above safety precaution. Should the appliance power supply cable need to be replaced, this must be carried out by our Service Centre.



Please ensure that when the appliance is installed the power supply cable is easily accessible.

## Environment concerns

### Packaging materials



The materials marked with the symbol  are recyclable.

>PE<=polyethylene

>PS<=polystyrene

>PP<=polypropylene

This means that they can be recycled by disposing of them properly in appropriate collection containers.

### Old machine

Use authorised disposal sites for your old appliance. Help to keep your country tidy!



The symbol  on the product or on its packaging indicates that this product may not be treated as household waste. Instead it shall be handed over to the applicable collection point for the recycling of electrical and electronic equipment. By ensuring this product is disposed of correctly, you will help prevent potential negative consequences for the environment and human health, which could otherwise be caused by inappropriate waste handling of this product. For more detailed information about recycling of this product, please contact your local city office, your household waste disposal service or the shop where you purchased the product.

## Ecological hints



To save water, energy and to help protect the environment, we recommend that you follow these tips:

- Normally soiled laundry may be washed without prewashing in order to save detergent, water and time (the environment is protected too!).
- The machine works more economically if it is fully loaded.
- With adequate pre-treatment, stains and limited soiling can be removed; the laundry can then be washed at a lower temperature.
- Measure out detergent according to the water hardness, the degree of soiling and the quantity of laundry being washed.

## Guarantee conditions

### Belgium

#### DECLARATION OF GUARANTEE TERMS.

Our appliances are produced with the greatest of care. However, a defect may still occur.

Our consumer services department will repair this upon request, either during or after the guarantee period. The service life of the appliance will not, however, be reduced as a result.

This declaration of guarantee terms is based on European Union Directive 99/44/EC and the provisions of the Civil Code. The statutory rights that the consumer has under this legislation are not affected by this declaration of guarantee terms.

This declaration does not affect the vendor's statutory warranty to the end user. The appliance is guaranteed within the context of and in adherence with the following terms:

1. In accordance with provisions laid down in paragraphs 2 to 15, we will remedy free of charge any defect that occurs within 24 months from the date the appliance is delivered to the first end user. These guarantee terms do not apply in the event of use for professional or equivalent purposes.
2. Performing the guarantee means that the appliance is returned to the condition it was in before the defect occurred. Defective parts are replaced or repaired. Parts replaced free of charge become our property.
3. So as to avoid more severe damage, the defect must be brought to our attention immediately.
4. Applying the guarantee is subject to the consumer providing proof of purchase showing the purchase and/or delivery date.
5. The guarantee will not apply if damage caused to delicate parts, such as glass (vitreous ceramic), synthetic materials and rubber, is the result of inappropriate use.
6. The guarantee cannot be called on for minor faults that do not affect the value or the overall reliability of the appliance.
7. The statutory warranty does not apply when defects are caused by:
  - a chemical or electrochemical reaction caused by water,
  - abnormal environmental conditions in general,
  - unsuitable operating conditions,
  - contact with harsh substances.
8. The guarantee does not apply to defects due to transport which have occurred outside of our responsibility. Nor will the guarantee cover those caused by inadequate installation or assembly, lack of maintenance or failure to respect the assembly instructions or directions for use.
9. Defects that result from repairs or measures carried out by people who are not qualified or expert or defects that result from the addition of non-original accessories or spare parts are not covered by the guarantee.
10. Appliances that are easy to transport may be delivered or sent to the consumer services department. Home repairs are only anticipated for bulky appliances or built-in appliances.
11. If the appliances are built-in, built-under, fixed or suspended in such a way that removing and replacing them in the place where they are fitted takes more than half an hour, the costs that result therefrom will be charged for.

Connected damage caused by these removal and replacement operations will be the responsibility of the user.

12. If, during the guarantee period, repairing the same defect repeatedly is not conclusive, or if the repair costs are considered disproportionate, in agreement with the consumer, the defective appliance may be replaced with another appliance of the same value. In this event, we reserve the right to ask for a financial contribution calculated according to the length of time it has been used.
13. A repair under guarantee does not mean that the normal guarantee period will be extended nor that a new guarantee period begins.
14. We give a twelve month guarantee for repairs, limited to the same defect.
15. Except in the event where liability is legally imposed, this declaration of guarantee terms excludes any compensation for damage outside the appliance for which the consumer wishes to assert his rights. In the event of legally admitted liability, compensation will not exceed the purchase price paid for the appliance.

These guarantee terms are only valid for appliances purchased and used in Belgium. For exported appliances, the user must first make sure that they satisfy the technical conditions (e.g.: voltage, frequency, installation instructions, type of gas, etc.) for the country concerned and that they can withstand the local climatic and environmental conditions. For appliances purchased abroad, the user must first ensure that they meet the qualifications required in Belgium.

Non-essential or requested adjustments are not covered by the guarantee and are not possible in all cases.

Our consumer services department is always at your disposal, even after the guarantee period has expired.

### **Address for our consumer services department:**

#### **Belgium**

Electrolux Home Products Belgium  
ELECTROLUX SERVICE

Bergensesteenweg 719 1502 Lembeek

Consumer services:

**Tel.** . . . 02/363.04.44

**Fax.** . . 02/363.04.00  
02/363.04.60

E-mail: [consumer.services@electrolux.be](mailto:consumer.services@electrolux.be)

#### **Luxembourg**

Grand-Duché de Luxembourg  
ELECTROLUX HOME PRODUCTS

Rue de Bitbourg. 7 L-1273  
Luxembourg-Hamm

Consumer services:

**Tel.** . . . 00 352 42 431-1

**Fax.** . . 00 352 42 431-360

E-mail: [consumer-service.luxembourg@electrolux.lu](mailto:consumer-service.luxembourg@electrolux.lu)

## European guarantee

This appliance is guaranteed by Electrolux, in each of the countries listed in the following page, for the period specified in the appliance guarantee or otherwise by law. If you move from one of these countries to another of these countries the appliance guarantee will move with you subject to the following qualifications:

- The appliance guarantee starts from the date you first purchased the appliance which will be evidenced by production of a valid purchase document issued by seller of the appliance.

### 38 electrolux guarantee conditions

- The appliance guarantee is for the same period and to the same extent for labour and parts as exists in your country of residence for this particular model or range of appliances.
- The appliance guarantee is personal to the original purchaser of the appliance and cannot be transferred to another user.
- The appliance is installed and used in accordance with instructions issued by Electrolux and is only used within the home, i.e. is not used for commercial purposes.
- The appliance is installed in accordance with all relevant regulations in force within your new country of residence.

The provisions of this European Guarantee do not affect any of the rights granted to you by law.

**www.electrolux.com**

		
Belgique/België/Belgien	+32 2 363 04 44	Bergensesteenweg 719, 1502 Lembeek
Česká republika	+420 2 61 12 61 12	Bud jovická 3, Praha 4, 140 21
Danmark	+45 70 11 74 00	Sjællandsgade 2, 7000 Fredericia
Deutschland	+49 180 32 26 622	Muggenhofer Str. 135, 90429 Nürnberg
Eesti	+37 2 66 50 030	Mustamäe tee 24, 10621 Tallinn
España	+34 902 11 63 88	Carretera M-300, Km. 29,900 Alcalá de Henares Madrid
France	www.electrolux.fr	
Great Britain	+44 8705 929 929	101 Oakley Road LUTON Beds LU4 9RJ
Hellas	+30 23 10 56 19 70	4, Limnou Str., 54627 Thessaloniki
Hrvatska	+38 51 63 23 338	Slavonska avenija 3, 10000 Zagreb
Ireland	+353 1 40 90 753	Longmile Road Dublin 12
Italia	+39 (0) 434 558500	C.so Lino Zanussi, 26 - 33080 Porcia (PN)
Latvija	+37 17 84 59 34	Kr. Barona iela 130/2, LV-1012, Riga
Lituanija	+370 5 27 80 609	Verkiu 29, 09108 Vilnius, Lithuania
Luxembourg	+35 2 42 43 13 01	Rue de Bitbourg, 7, L-1273 Hamm
Magyarország	+36 1 252 1773	H-1142 Budapest XIV, Erzsébet királyné útja 87
Nederland	+31 17 24 68 300	Vennootsweg 1, 2404 CG - Alphen aan den Rijn
Norge	+47 81 5 30 222	Risløkkvn. 2 , 0508 Oslo
Österreich	+43 18 66 400	Herziggasse 9, 1230 Wien
Polska	+48 22 43 47 300	ul. Kolejowa 5/7, Warsaw
Portugal	+35 12 14 40 39 39	Quinta da Fonte - Edificio Gonçalves Zarco - Q35 -2774-518 Paço de Arcos
Romania	+40 21 44 42 581	B-dul Timisoara 90, S6, Bucharest
Schweiz-Suisse-Svizzera	+41 62 88 99 111	Industriestrasse 10, CH-5506 Mägenwil
Slovenija	+38 61 24 25 731	Tr aška 132, 1000 Ljubljana
Slovensko	+421 2 43 33 43 22	Electrolux Slovakia s.r.o., Electrolux Domáce spotrebizne SK, Seberního 1, 821 03 Bratislava
Suomi	+35 8 26 22 33 00	Konepajaranta 4, 28100 Pori
Sverige	+46 (0)771 76 76 76	Electrolux Service, S:t Göransgatan 143, S-105 45 Stockholm
Türkiye	+90 21 22 93 10 25	Tarlabađ caddesi no : 35 Taksim Istanbul
Россия	+7 095 937 7837	129090 Москва, Олимпийский проспект, 16, БЦ "Олимпик"



[www.electrolux.com](http://www.electrolux.com)  
[www.electrolux.be](http://www.electrolux.be)

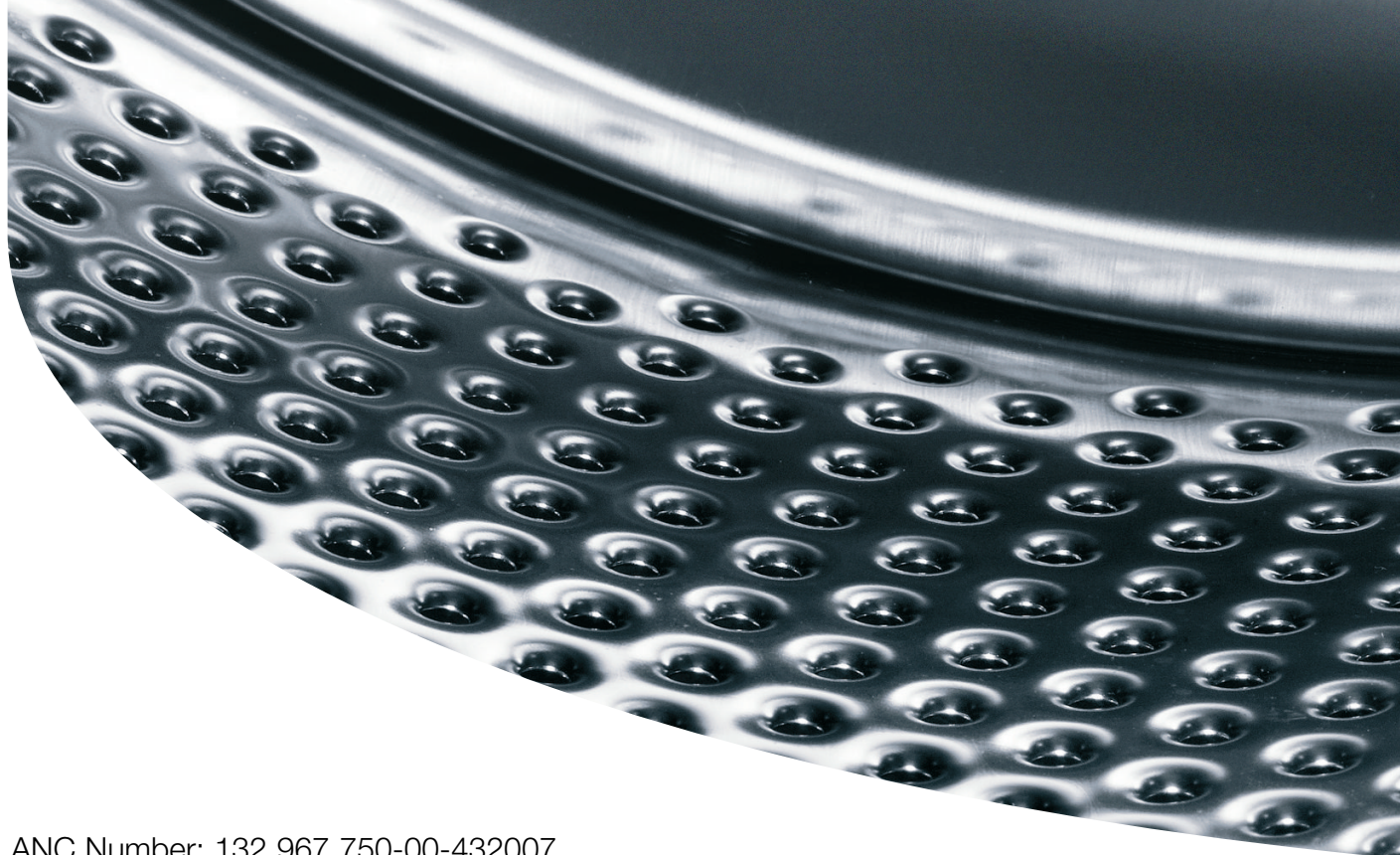

ANC Number: 132 967 750-00-432007