

5/12/01  
682-7025

**READ AND SAVE THESE INSTRUCTIONS**

**WELBILT®**

**THE BREAD MACHINE**



**MODEL: ABM6900**

048-5228

Machine

∞

## IMPORTANT SAFEGUARDS

**WHEN USING ELECTRICAL APPLIANCES, BASIC SAFETY PRECAUTIONS SHOULD ALWAYS BE FOLLOWED, INCLUDING THE FOLLOWING:**

1. Read all instructions carefully.
2. Do not touch hot surfaces. Use handles or knobs and a potholder. Do not close or clog the steam vent openings under any circumstances.
3. To protect against electrical shock, do not immerse cord, plug, or any other part of this bread machine, in water or other liquid.
4. Close supervision is necessary when any appliance is used by or near children.
5. Unplug the power supply cord when the appliance is not in use, or before cleaning. Allow to cool before putting on or taking off any parts.
6. Do not use or operate the appliance with a damaged cord or plug, or after the appliance malfunctions or has been damaged in any manner. Return appliance to the nearest authorized service facility for examination, repair or adjustment.
7. The use of accessory attachments not recommended or sold by the manufacturer may cause injuries.
8. Do not use outdoors.
9. Do not let the power supply cord hang over the edge of table or counter, or touch hot surfaces.
10. Do not place the appliance on or near hot gas or electric burners, or in a heated oven.
11. Extreme caution must be used when moving an appliance containing hot contents or liquids.
12. To disconnect, press STOP, then remove plug from wall outlet. Grip plug and pull from wall outlet. Never pull on the cord.
13. Do not use the bread machine for other than intended use.
14. Avoid contact with moving parts during operation.
15. Do not pour any ingredients directly into the bread machine -- only into the baking pan. The baking pan must then be placed in the machine.
16. Do not operate this appliance in the presence of explosive and/or flammable fumes.
17. This appliance is intended for household use only and not for commercial or industrial use.
18. To avoid damaging the machine, do not place the baking pan or any object on top of the unit.
19. Do not clean with scouring pads. The baking pan and kneading blade have a nonstick coating. Refer to "Cleaning" section of this book.
20. Do not use bread machine for storage purposes nor insert any utensils, as they may create a fire or electric shock.

## SAVE THESE INSTRUCTIONS

### HOUSEHOLD USE ONLY

This appliance has a polarized plug (one blade is wider than the other). As a safety feature, this plug will fit in a polarized outlet only one way. If the plug does not fit fully in the outlet, reverse the plug. If it still does not fit, contact a qualified electrician. **DO NOT ATTEMPT TO DEFEAT THIS SAFETY FEATURE.**

A short power-supply cord is provided to reduce the risk of becoming entangled in or tripped over a longer cord. An extension cord may be used if precautions are taken in their use. If an extension cord is used:

1. The marked electrical rating of the extension cord should be at least as great as the electrical rating of the appliance, and
2. The cord should be arranged so that it will not drape over the countertop or tabletop where it can be pulled on by children or tripped over accidentally.

## ABOUT YOUR BREAD MACHINE

- Your bread machine makes REGULAR (1 lb.), LARGE (1 1/2 lb.) and EXTRA LARGE (2 lb.) horizontal-shaped loaves of breads.
- Your bread machine has 11 settings, including one for dough.
- A Keep Warm function prevents the bread from getting soggy by keeping finished bread warm up to an hour after the baking is completed. This function stops when the unit is turned OFF/STOP or unplugged.
- A Fruit and Nut beep signals when it is time to add ingredients, such as fruits or nuts, to recipes used with the **Basic Breads** (1-3) and **Sweet** (8) settings. The beep sounds 32 minutes into the cycle (after initial kneading) so that your fruit or nuts will remain whole rather than be chopped up by the kneading blade. If you use the TIMER to delay baking, you may add all ingredients at once and bypass this function; however, your fruit or nuts may get somewhat chopped.
- Do not cover the bread machine with towels or other material that may prevent steam from escaping. Some steaming from vents is normal.
- Do not place any objects on top of the bread machine.
- Unplug the unit and wait until it cools, then remove any spilled ingredients or crumbs from the baking chamber of the bread machine by wiping with a damp sponge or cloth. See "Care and Cleaning", page 11.
- **IMPORTANT:** Always add ingredients in the order they are specified in the recipe. For best results, **accurate measuring of ingredients is very important.** Do not put larger quantities than recommended into the baking pan as it may produce poor results and may damage the bread machine.

## BEFORE YOUR FIRST USE

Enjoy using your Welbilt Bread Machine. Before your first use, please take a few minutes to read this Instruction Manual and keep it handy for reference. Pay particular attention to the safety instructions we have provided for your protection.

Carefully unpack the bread machine and remove all packaging materials. To remove any dust that may have accumulated during packing, wipe the baking pan, kneading blade and outside surface of the bread machine with a clean, damp cloth. Do not use scouring pads or any abrasives on any part of the bread machine.

Plug the cord into a 120-volt AC outlet. The cord length of this bread machine was selected to reduce the possibility of tangling or tripping over a longer cord. If more cord length is needed, use a UL certified extension cord rated no less than 15 amperes and 120 volts. The longer cord should be arranged so that it will not drape over the countertop where it can be pulled on by children or tripped over.

## TABLE OF CONTENTS

### OPERATING INSTRUCTION SECTION

Important Safeguards	1
About Your Bread Machine	2
Before Your First Use	3
Know Your Bread Machine	4
Control Panel	5
Setting Descriptions	6
Using Your Bread Machine	7-10
Using the Timer	10
Slicing And Storing Bread	10
Care and Cleaning	11
Bread Machine Cycle Times	12
Know Your Ingredients	13-15
Measuring Your Ingredients	16
Recipe Tips	17
Creating Your Own Yeast Breads	17
Special Glazes For Yeast Breads	17

### RECIPE SECTION

Basic White Bread	18
Onion Bread	18
Rye Bread	18
Cinnamon Raisin Nut Bread	19
Egg Bread	19
Honey Oats Bread	19

100% Whole Wheat Bread	20
Shredded Wheat Bread	20
Triple Wheat Bread	20
Pumpnickel Bread	21
French Bread	21
Holiday Bread	21
<b>Tips for Making Dough</b>	22
Cinnamon Rolls	22
Bagels	23
French Baguettes	24
Breadsticks	24
Rich Sweet Breads	25
Pizza Crust	25
Apple Walnut Bread	26
Banana Nut Bread	26
Irish Soda Bread	26
Corn Bread	27
Carrot Pecan Bread	27
Chocolate Chip Zucchini Bread	27
Easy Lowfat Cake	28
Strawberry Jam	28
Recipe Notes	28

### HELP SECTION

Troubleshooting	29
Need Help? (Questions and Answers)	30-32
Baking Tips Guide	33-34

# KNOW YOUR BREAD MACHINE

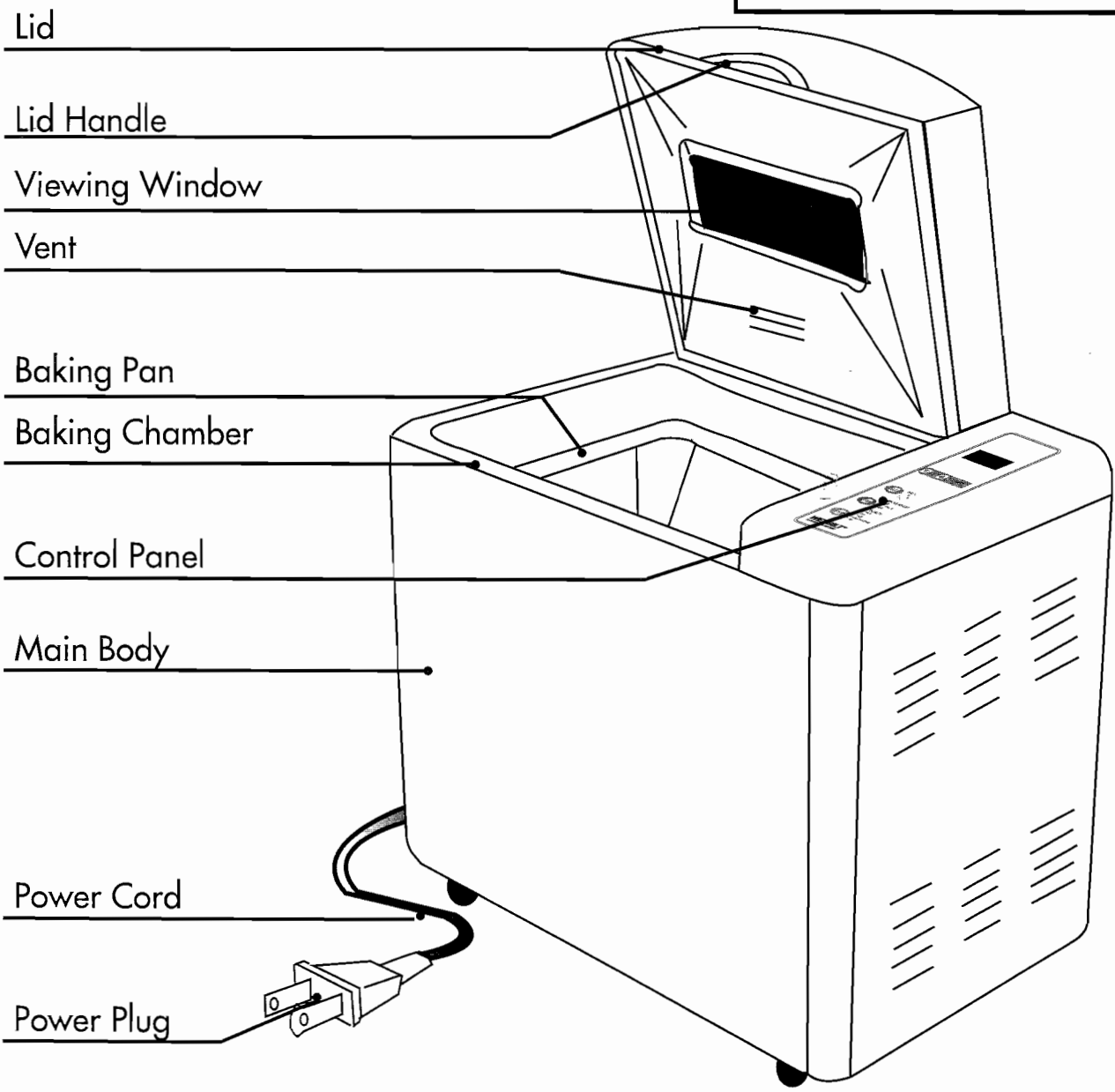
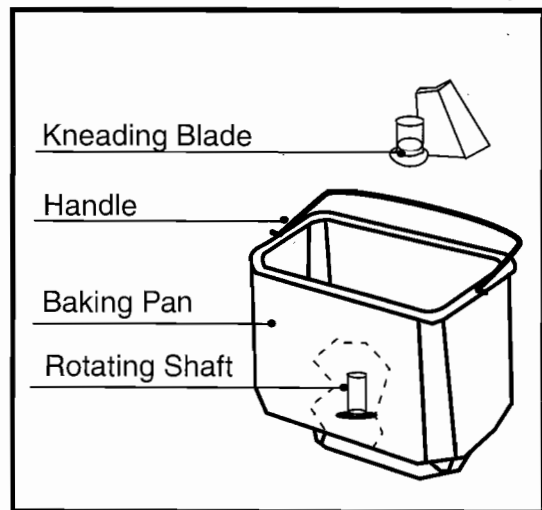

# CONTROL PANEL

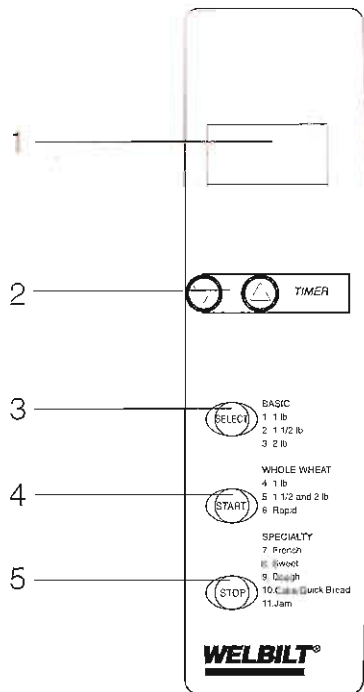

**NOTE:** When using the touchpad controls, be sure to press the pad until you hear a beep.

<p><b>1 DISPLAY WINDOW</b></p>	<ul style="list-style-type: none"> <li>- Shows the Setting Number selected (1 through 11).</li> <li>- Shows minute-by-minute baking time countdown.</li> </ul>
<p><b>2 TIMER</b></p>	<p>Use when setting the TIMER to delay baking.</p> <ul style="list-style-type: none"> <li>- Press ▲ and ▼ arrows to set timer for delayed completion up to 12 hours later.</li> <li>- Arrows will move time up or down in 10-minute increments. Press and hold button for faster movement. Timer can be used only after selecting the setting.</li> </ul>
<p><b>3 SELECT</b></p>	<ul style="list-style-type: none"> <li>- Press to select the setting of your choice (1 through 11). The selected setting automatically assigns the time needed to complete the process.</li> </ul>
<p><b>4 START</b></p>	<ul style="list-style-type: none"> <li>- Press to start operation or begin Timer countdown for delayed completion.</li> </ul>
<p><b>5 STOP</b></p>	<ul style="list-style-type: none"> <li>- Press and hold until you hear a beep to stop operation or cancel a Timer setting. (Note: Do not press "STOP" when you are just checking the progress of bread.)</li> </ul>

# SETTING DESCRIPTIONS

**NOTE:** The numbers in parentheses indicate total time to complete setting selected.

## BASIC BREADS

These settings are used for breads that primarily use white flour; though some recipes may include small amounts of whole wheat flour as well. These settings have the minimum number of rising cycles and the shortest overall times until baking is completed. Therefore, loaves will be slightly denser than French or Sweet breads. Choose from three Basic settings, according to loaf size:

**SETTING 1 - Basic 1 Pound (2 hours, 45 minutes)**

**SETTING 2 - Basic 1 1/2 Pound (2 hours, 50 minutes)**

**SETTING 3 - Basic 2 Pound (3 hours, 10 minutes)**

## WHOLE WHEAT/MULTI-GRAIN

These settings are used for recipes with significant amounts of whole wheat or rye flour, oats or bran. They begin with a rest period during which the flours or grains absorb the liquid ingredients. Soaking causes the flour or grain to soften and helps ingredients to combine well. These settings also have an extra rise cycle to allow heavy wheat/grains to expand. Generally, whole wheat/multi-grain breads are shorter and denser than Basic, French, or Sweet breads. Choose from three Whole Wheat settings:

**SETTING 4 - Whole Wheat 1 Pound (4 hours, 20 minutes)**

**SETTING 5 - Whole Wheat 1 1/2 Pound and 2 Pound (4 hours, 30 minutes)**

**SETTING 6 - Whole Wheat Rapid (3 hours, 20 minutes)**

Use this setting for 100% whole grain breads when time is limited. Breads made using this setting will be shorter and more dense.

## SPECIALTY

**SETTING 7 - French (3 hours, 30 minutes)**

Traditionally French bread has a crispier crust and lighter texture than basic breads. Recipes usually do not include butter, margarine or milk.

**SETTING 8 - Sweet (3 hours, 25 minutes)**

Use this setting for recipes that use fruit juice, additional sugar, or added sweet ingredients such as coconut flakes, raisins, dried fruit or chocolate. Baking temperature is reduced to prevent burning and the extra rise cycle gives the loaves a light, airy texture.

**SETTING 9 - Dough (1 hour, 30 minutes)**

This setting makes dough only and will not bake the final bread. Remove the dough and shape to make pizza, rolls, pretzels, doughnuts and round or braided breads. Then bake in a conventional oven or fry in a deep fryer (ie. doughnuts). Follow dough recipes for specific directions.

**SETTING 10 - Cake/Quick Bread (1 hour, 40 minutes)**

Use this setting for recipes that contain baking powder or baking soda rather than yeast to make them rise. Cake recipes must be specially designed for this setting. See the recipe section for the cake recipe.

**SETTING 11 - Jam (1 hour)**



Use this setting for making jam from fresh fruits. Do not double recipes or allow ingredients to boil over the pan into the baking chamber. Should this happen, stop the machine immediately. Allow to cool and clean thoroughly.

# USING YOUR BREAD MACHINE

The 8 bread settings in this unit will combine ingredients, knead, and make bread from start to finish automatically. The DOUGH setting makes dough for a variety of recipes for you to shape and bake in your oven. To delay completion, the automatic TIMER may be programmed to make bread or dough while you are at work or asleep. (See "Using The Timer", page 10.)

The recipes included with this booklet have been thoroughly tested to ensure best results. Recipes have been created by home economists specifically for this bread machine and may not produce acceptable results in other similar bread machines.

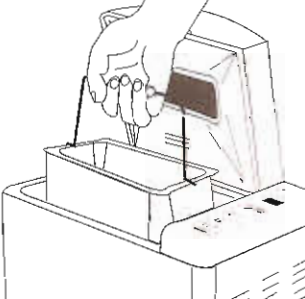
## FOR ALL SETTINGS (1 THRU 11), FOLLOW THESE INSTRUCTIONS:

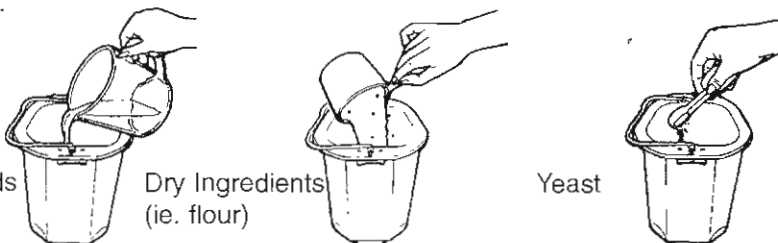
<p><b>1</b></p>	<p>Open the lid and remove the baking pan by pulling straight up on the handle. It is important to remove the baking pan from the unit rather than putting ingredients into the pan while it is in place to avoid accidentally spilling ingredients into the baking chamber.</p> 	<p><b>Warning:</b> Place your bread machine where it is level, stable and secure.</p>
<p><b>2</b></p>	<p>Attach the kneading blade onto the shaft inside the baking pan by lining up the flat side of the blade with the flat side on the shaft. Push the blade firmly onto the shaft.</p> 	<ul style="list-style-type: none"> <li>• Be sure to set the kneading blade firmly into place otherwise the blade may come off during operation, which may affect the kneading or mixing.</li> <li>• Be sure the shaft is clean of any residue (i.e. dough). This will ensure the kneading blade will fully seat into place.</li> </ul>
<p><b>3</b></p>	<p>Select a recipe from the recipe section of this booklet. When following the recipes:</p> <ul style="list-style-type: none"> <li>- Measure ingredients carefully and accurately. To measure liquids, use a see-through liquid measuring cup and check the measurement at eye level. When measuring dry ingredients, use a standard dry measuring cup and level the ingredients with a straightedge knife. Inaccurate measurement, even slightly, can make a difference in results. Use standard measuring spoons and level off with a straightedge knife. (See "Measuring Your Ingredients", page 16.)</li> <li>- Always add ingredients into the baking pan in the order listed.</li> <li>- Always add yeast last. Be sure the yeast does not touch the liquid ingredients.</li> </ul> 	<p>Be careful not to mix the yeast with any of the wet ingredients, especially when using the delayed timer feature. Otherwise, the bread may not rise properly.</p>



# USING YOUR BREAD MACHINE

**4**

Place the baking pan back into the unit with the word FRONT on the upper rim of the pan facing toward the front of the bread machine. Push down on the pan until you hear it click firmly into place. Fold the handle down.

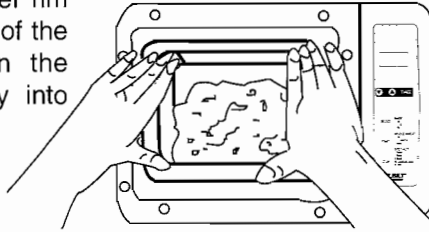

**Special Note:**

If the baking pan is not installed properly or firmly clicked into place, the kneading blade will not operate. The baking pan can only be installed in one position as indicated.

**5**

Close the lid. Connect the plug to a 120-volt AC-only outlet. You will hear a beep and the display will be blank.

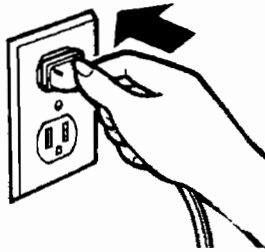

**Caution:**

This appliance has a polarized plug (one blade is wider than the other). As a safety feature, this plug will fit in a polarized outlet only one way. If the plug does not fit fully in the outlet, reverse the plug. If it still does not fit, contact a qualified electrician. Do not attempt to defeat this safety feature.

**6**

Choose the correct setting for your recipe (1 thru 11) by pressing the SELECT button. Each time SELECT is pressed, the number in the display window will advance to the next setting.

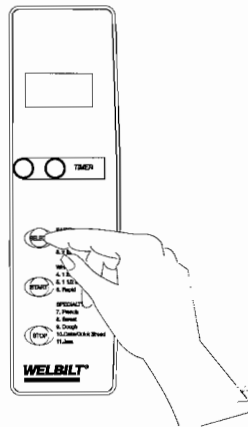

**Special Note:**

The Whole Wheat settings begin with a rest period during which the flours or grains absorb the liquid ingredients. Soaking causes the flour or grain to soften and helps ingredients to combine well. There is no blade action during this period.

**7**

Press the START pad. The total baking time will appear in the display. For example, if you choose a recipe using Basic Bread Setting #1, the display will show 2:45. The remaining time will count down in one-minute increments. When the baking time is completed, a beep will sound three times and the display window will flash "END".

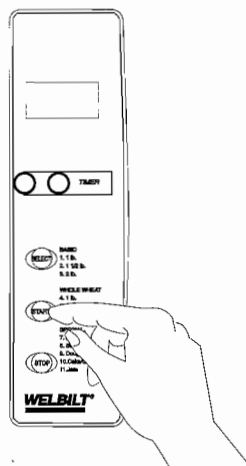

**Warning:**

To avoid damaging the bread machine, do not put any object on top of the unit.

**Breadmaking Tip:**

After 5 minutes of kneading, open the lid of the bread machine and check the dough consistency. The dough should form a soft, tacky ball. If too dry, add liquid; if too wet, add flour -- 1/2 to 1 tablespoon at a time.

## USING YOUR BREAD MACHINE

**8** Your bread machine is designed with a Keep Warm feature that automatically begins when the bake time is completed. At the end of the bake cycle, "END" will flash in the display window. This will continue for up to 60 minutes after baking is complete. During this time, the bread machine will circulate hot air to keep the bread warm. You may remove the baking pan at any time during the Keep Warm cycle. To turn off the Keep Warm feature before the 60 minutes are up, simply press the STOP button and hold it for 3 seconds until you hear a beep. "END" will disappear, and the display window will be blank. **UNPLUG THE UNIT WHEN FINISHED. Never leave the unit plugged in when not in use.**

**Note:**

The "Keep Warm" feature does not function on Dough setting #9.

**9** This bread machine has a convenient viewing window so that you may watch the progress of the bread as it is mixed, kneaded and baked. Occasionally, some moisture may form in the window during baking. You may lift the lid to look inside during mixing and kneading stages. However, **DO NOT OPEN THE LID DURING THE BAKING CYCLE** (approximately the last hour or so) as this may cause the bread to collapse.

**10** To remove the bread from the baking pan, use pot holders or oven mitts and pull straight up on the handle. Turn the pan upside down and shake the bread out onto a wire cooling rack. The baking pan has a nonstick finish so the bread should come out easily. Do not use metal utensils to remove bread as they may scratch the nonstick surface. If you have difficulty removing bread from the baking pan, slide a flat rubber or plastic spatula along the sides of the pan to loosen the loaf. Turn the pan over and shake the loaf out.

Always check to see where the kneading blade is when removing a baked loaf of bread. If it remains stuck in the bread, you may damage it by cutting into it while slicing.

Allow the bread to cool before slicing (See "Slicing and Storing Bread" page 10). If the kneading blade remains in the bottom of the baking pan, fill the baking pan with warm water to loosen. If the kneading blade remains in the bottom of the bread, use the end of a plastic spoon or other nonmetal utensil to remove. Do not use a knife or any other sharp metal object as it will scratch the nonstick coating on the kneading blade.

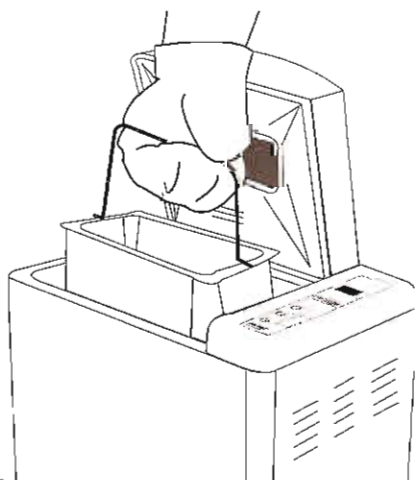

# USING YOUR BREAD MACHINE

## USING THE TIMER

Use the TIMER when you want to delay the completion of your bread for up to 12 hours. For example, you can set the TIMER at 8 p.m. one evening so you can wake up to fresh bread by 8 a.m. the following morning.

### TO SET THE TIMER, FOLLOW THESE INSTRUCTIONS:

	<b>NOTE:</b> First, follow steps 1 thru 6 in "Using Your Bread Machine", pages 7-8. Do not use the TIMER with recipes that call for perishable ingredients, such as eggs, fresh milk, sour cream, or cheese.
<b>1</b>	To set the TIMER, decide when you want your bread to be finished. For example, it is 8 p.m. and you want to wake up to fresh-baked Sweet bread at 8 a.m. -- a total of 12 hours before your bread is complete. Once you select the correct setting for your recipe, you simply set the TIMER to bring it up to your total hours, in this case 12 hours.
<b>2</b>	Press the ▲ arrow on the control panel and 3:25 (the time for Sweet setting #8) will appear in the display window. Continue to Press ▲ until the display reads 12:00 (or is as close as possible since the timer moves in 10-minute increments). You do not need to mathematically calculate the difference between the setting time (3:25) and the total hours you want (12:00). The machine will automatically adjust to include the setting time. Simply set the TIMER for your total hours (12). If you pass the desired time, simply press ▼ to go back.
<b>3</b>	Once you have set the time, press START. The colon (:) in the display will flash to indicate that the TIMER has been set, and the countdown will begin. The TIMER will count down in one-minute increments. When the display reaches END, your bread is complete and the beeper will sound.
<b>4</b>	If you make a mistake while setting the TIMER, press and hold the STOP button until it beeps. This will clear the display, and you can select the setting and set the TIMER again.

## SLICING AND STORING BREAD

For best results, place bread on a wire rack and allow to cool 15 to 30 minutes before slicing. Use an electric knife for even slices. Otherwise, use a sharp serrated knife. For square slices, place the loaf on its side and slice across.

Store unused bread tightly covered (reclosable plastic bags or plastic containers work well) at room temperature up to three days. For longer storage (up to one month), place bread in a tightly covered container in the freezer. Since homemade bread has no preservatives, it tends to dry out and become stale faster than commercially-made bread.

Leftover slightly hardened bread may be cut into 1/2-inch or 1-inch cubes and used in recipes to make croutons, bread pudding or stuffing.

# CARE AND CLEANING

## CAUTION:

To prevent electrical shock, unplug the unit before cleaning. Allow the bread machine to cool before cleaning. Do not immerse or splash either the body or lid in any liquid as this may cause damage and/or electric shock.

For best performance and maintenance, clean the bread machine after each use as follows:

### Outer Body, Lid and Baking Chamber:

Wipe the lid and outer body of the unit with a damp cloth or slightly dampened sponge. Use a damp sponge or cloth to wipe out any flour, crumbs or other materials from the baking chamber. Dry thoroughly.

### Baking Pan and Kneading Blade:

Both the baking pan and kneading blade have nonstick surfaces. Do not use any harsh cleansers, abrasive materials or utensils on these parts that may scratch their surfaces. Over time, the nonstick surface may change in appearance due to moisture and steam. This is normal and has no effect on its use or quality.

Remove the baking pan and kneading blade from the baking chamber before cleaning. Wipe the outside of the baking pan with a damp cloth. NEVER IMMERSE THE BAKING PAN in water or other liquid. Wash the inside of the baking pan with warm, soapy water. If the kneading blade gets stuck, fill the baking pan with hot water and soak for 30 minutes or until it loosens and can be removed easily. If the hole in the kneading blade becomes clogged, carefully clean it out with a wooden or plastic toothpick.

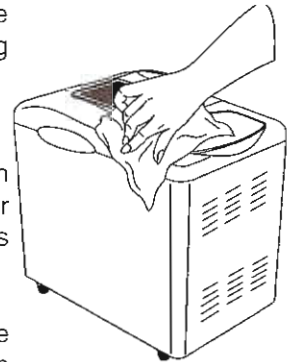

Never use any of the following to clean your bread machine:

- Paint Thinner
- Benzine
- Steel Wool Pads
- Polishing Powder
- Chemical Dustcloth

**CAUTION:** DO NOT place any part or parts of the bread machine in the dishwasher.

## STORING THE UNIT

Be sure to dry all parts before storing including the viewing window. Close the lid, and do not store anything on top of the bread machine.

## TROUBLESHOOTING

Specific questions about the bread machine functions and problems with ingredients or recipes are addressed in the "Need Help?" section on pages 30-32. For better performance, allow the unit to cool completely before beginning to bake a second loaf of bread. You can speed cooling by opening the lid, removing the baking pan, and allowing the baking chamber to cool.

# BREAD MACHINE CYCLE TIMES

SETTING	1	2	3	4	5	6	7	8	9	10	11
CYCLE	BASIC 1 lb.	BASIC 1.5 lb.	BASIC 2 lb.	WHOLE WHEAT 1 lb.	WHOLE WHEAT 1.5 lb./ 2 lb.	WHOLE WHEAT RAPID	FRENCH	SWEET	DOUGH	CAKE / QUICK BREAD	JAM
Rest*	-	-	-	30 min.	30 min.	15 min.	-	-	-	-	-
Knead 1	6 min.	6 min.	6 min.	6 min.	6 min.	6 min.	6 min.	6 min.	6 min.	6 min.	45 min.
Knead 2	27 min.	31 min.	31 min.	18 min.	25 min.	25 min.	22 min.	31 min.	24 min.	4 min.	15 min.
Rise 1	23 min.	29 min.	29 min.	76 min.	79 min.	39 min.	34 min.	40 min.	60 min.	-	-
Punch 1	-	-	-	10 sec.	15 sec.	15 sec.	5 sec.	5 sec.	-	-	-
Punch 2	-	-	-	-	-	-	10 sec.	10 sec.	-	-	-
Punch 3	-	-	-	-	-	-	5 sec.	5 sec.	-	-	-
Rest	-	-	-	30 min.	30 min.	15 min.	29 min.	29 min.	---		
Shape 1	5 sec.	5 sec.	5 sec.	3 sec.	3 sec.	3 sec.	5 sec.	5 sec.	-	-	-
Shape 2	10 sec.	10 sec.	10 sec.	-	-	-	10 sec.	10 sec.	-	-	-
Shape 3	5 sec.	5 sec.	5 sec.	-	-	-	5 sec.	5 sec.	-	-	-
Rise 2	64 min.	54 min.	54 min.	55 min.	45 min.	45 min.	54 min.	49 min.	-	-	-
Bake	45 min.	50 min.	70 min.	45 min.	55 min.	55 min.	65 min.	50 min.	-	90min.	-
Keep Warm	60 min.	60 min.	60 min.	60 min.	60 min.	60 min.	60 min.	60 min.	-	60 min.	-
Total **											
Time	2:45	2:50	3:10	4:20	4:30	3:20	3:30	3:25	1:30	1:50	1:00

\*The Whole Wheat cycles begin with a rest period during which the flours or grains absorb the liquid ingredients. Soaking causes the flour or grain to soften and helps ingredients to combine well. There is no blade action during this period.

\*\*Total Time does not include "Keep Warm".

# KNOW YOUR INGREDIENTS

It is often said that cooking is an art relying on the creativity of the chef, while baking bread is much more of a science. This means that the process of combining flour, water and yeast results in a chemical reaction that produces bread. You have to remember that when the ingredients combine with each other they produce a specific result. Read the following information carefully to gain a better understanding of the importance each ingredient plays in the breadmaking process.

## 1. ALL-PURPOSE FLOUR

All-purpose flour is a blend of refined hard and soft wheat flours especially suitable for making breads and cakes. The most popular brands of flour have been tested for quick bread in The Bread Machine by Welbilt® with excellent results.

## 2. BREAD FLOUR

Bread flour is a high gluten/protein flour that has been treated with conditioners to give dough a greater tolerance during kneading. Bread flour typically has a higher gluten concentration than all-purpose flour. Using bread flour with your bread machine will produce loaves with better volume and structure.

## 3. WHOLE WHEAT FLOUR

Whole wheat flour is milled from the entire wheat kernel, which contains the bran and germ. Whole wheat flour is heavier and richer in nutrients than all-purpose flour. Breads made with this flour are usually smaller and heavier than white loaves. Many recipes mix whole wheat flour with bread flour or gluten to produce a high, light-textured bread.

## 4. RYE FLOUR

Rye flour is a high fiber flour similar to whole wheat flour, also called graham flour. Rye flour must always be mixed with a high proportion of bread flour, as it does not contain enough gluten to develop the structure for a high, even-grained loaf.

## 5. GLUTEN

Gluten is wheat flour that has been treated to remove nearly all the starch, which leaves a very high gluten content. (Gluten is the protein in the wheat that makes the dough elastic). Gluten is available at most health food stores. It is sometimes used in small portions with dense, low-gluten flours (such as whole wheat) to increase volume and lighten texture.

## 6. CAKE FLOUR

Cake flour is made from softer or lower protein wheats and is specially designed for use in cake recipes.

## 7. SELF-RISING FLOUR

Self-rising flour contain leavening ingredients that will interfere with bread and cake making. It is not recommended for use with your bread machine.

## IMPORTANT NOTE ON FLOURS

Flours, while visibly similar, can be very different by virtue of how they were grown, milled, stored, etc. You may have to experiment with different brands of flour to help you make the perfect loaf. See the "Baking Tips Guide" on pages 33 and 34 to assist you with these experiments.

Storage of flour is also very important. Keep flour in a secure, airtight container. Rye and whole wheat flours should be stored in a refrigerator, freezer or a cool area to prevent them from becoming rancid.

# KNOW YOUR INGREDIENTS

## 8. BRAN

Bran (unprocessed) and wheat germ are the coarse outer portions of the wheat or rye grains separated from flour by sifting or bolting. They are often added in small quantities to bread for nutritional enrichment, heartiness and flavor. They are also used to enhance bread texture.

## 9. CORNMEAL AND OATMEAL

Cornmeal and oatmeal come from coarsely ground white or yellow corn and from rolled or steel-cut oats. They are used primarily to enhance the flavor and texture.

## 10. CRACKED WHEAT

Cracked wheat has a very coarse texture. It comes from wheat kernels cut into angular fragments. It gives whole grain breads a nutty flavor and crunchy texture.

## 11. SEVEN GRAIN CEREAL BLEND

Seven Grain Cereal Blend is a blend of cracked wheat, oats, bran, rye, corn meal, flax seeds and hulled millet.

## 12. YEAST

Yeast, through a fermentation process, produces gas (carbon dioxide) necessary to make the bread rise. Yeast feeds on sugar and flour carbohydrates to produce this gas. Active dry granular yeast is used in all recipes that call for yeast. Three different types of yeast are available: fresh (cake), dry and quick acting. Bread machine yeast is quick acting. For best results, use traditional dry yeast; however, quick rising yeast can also be used in smaller amounts. (Note: The recipes in this cookbook were developed using traditional dry yeast.)

Always store yeast in a refrigerator to keep it fresh. Too much heat will kill it. Ensure your yeast is fresh by checking its expiration date. Once a package or jar of yeast is opened, it is important that the remaining contents be immediately resealed and refrigerated for future use. Often bread or dough that fails to rise is due to stale yeast. The following test can be used to determine if your yeast is stale and inactive:

- 1) Place 1/2 cup of lukewarm (110°F. - 115°F) water into a liquid measuring cup.
- 2) Stir 1 teaspoon of sugar into the water and then sprinkle 2 teaspoons of yeast over the surface.
- 3) Place bowl or cup in a warm area and allow to sit for 10-minutes undisturbed.
- 4) The mixture should foam and rise to the 1-cup mark. If this does not occur, discard this yeast and purchase fresh yeast.

### CONVERSION CHART FOR FAST-RISING YEAST

1 teaspoon active dry yeast = 3/4 teaspoon quick-rising yeast  
1 1/2 teaspoons active dry yeast = 1 teaspoon quick-rising yeast  
2 teaspoons active dry yeast = 1 1/2 teaspoons quick-rising yeast

## 13. SUGAR

Sugar is important for the color and flavor of breads. It also serves as food for the yeast as it supports the fermentation process. Recipes in this book that call for sugar require granulated sugar. Do not substitute powdered sugar unless indicated. Artificial sweeteners cannot be used as a substitute for sugar as the yeast will not react properly with them.

## 14. SALT

Salt is necessary to balance the flavor of breads and cakes, as well as for the crust color that develops during baking. Salt also limits the growth of yeast. Do not increase amount of salt shown in the recipes. For dietary reasons, salt may be eliminated; however, your bread may overproof and rise higher than normal.

# KNOW YOUR INGREDIENTS

## 15. LIQUIDS

Liquids, such as milk (1%, 2%, whole and skim), water or a combination of powdered milk and water, can be used when making bread. Milk will improve flavor, provide a velvety texture and soften the crust, while water alone will produce a crispier crust. Some recipes call for juice (orange, apple, etc.) to be added as a flavor enhancer.

## 16. EGGS

Eggs add richness and a velvety texture to bread doughs and cakes. Use large-size eggs in these recipes.

## 17. FATS: SHORTENING, BUTTER AND OIL

Shortening, butter and oil shorten or tenderize the texture of yeast breads. French bread gets its unique crust and texture from the lack of fat added. However, breads that call for fat stay fresh longer. If butter is used direct from the refrigerator, it should be cut into small pieces for easier blending during the kneading cycle.

## 18. BAKING POWDER

Baking powder is a leavening agent used in quick breads and cakes. This type of leavening agent does not require rising time before baking as the chemical reaction works when liquid ingredients are added.

## 19. BAKING SODA

Baking soda is another leavening agent not to be confused or substituted for baking powder. It also does not require rising time before baking as the chemical reaction works during baking process.



# MEASURING YOUR INGREDIENTS

The most important step when using your bread machine is measuring your ingredients. It is very important to measure each liquid and dry ingredient accurately. Mismeasuring, even slightly, can cause poor baking results. The ingredients must also be added into the baking pan in the order given in each recipe.

## Liquid Measurements

Use transparent plastic or glass liquid measuring cups to measure all liquid ingredients. Place the cup on a horizontal flat surface and view markings at eye level. The liquid level line must be aligned to the mark of measurement. A "guesstimate" is not good enough as it could throw off the critical balance of the recipe.

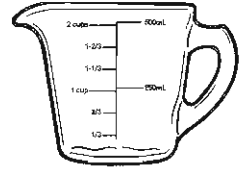

## Dry Measurements

Dry ingredients must be measured using standard size dry measuring cups. These cups are available in various sizes. Gently spoon dry ingredients into the measuring cup and level off with a knife (see Figs. 1 and 2 below). Do not scoop or tap a measuring cup as this will pack the ingredients. This extra amount could affect the balance of the recipe. Do not sift the flour.

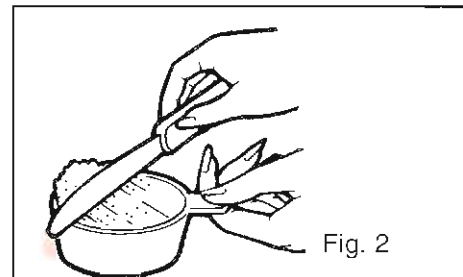
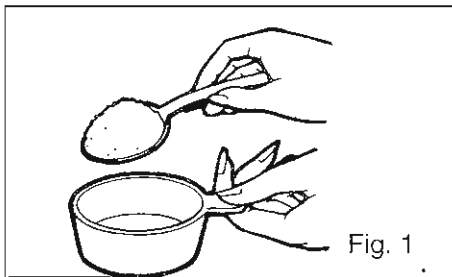

When measuring small amounts of dry or liquid ingredients (ie. yeast, sugar, salt, dry milk, honey or molasses) a standard measuring spoon must be used. Measurements must be level, not heaping.

Your bread machine produces delicious baked goods with ease. This marvelous machine asks only that you carefully follow the recipe instructions. In most cooking, "a pinch of this and a dash of that" is fine, but not for automatic bread machines. Using a bread machine correctly requires you accurately measure each ingredient.

## RECIPE TIPS

### CREATING YOUR OWN YEAST BREADS

With the Welbilt® Bread Machine, even the most inexperienced baker can achieve the satisfying experience of baking a loaf of bread. All of the mystery and hard work is gone. Inside this talented machine with a computer brain, the dough is mixed, kneaded, proofed, and baked without you being present. The bread machine can also prepare doughs for you to shape and bake in a conventional oven. The recipes included with this book are "tailored" for this Welbilt® Bread Machine. Each recipe features ingredients that best compliment a particular loaf of bread, and each was tested in our machines. It is extremely important not to exceed the amounts of flour specified in each of the recipes or this could result in unsatisfactory baking performance. When creating your own yeast bread recipes or baking an old favorite, use the recipes in this cookbook as a guide for converting portions from your recipe to your bread machine.

### SPECIAL GLAZES FOR YEAST BREADS

Give your just-baked bread a professional finish. Select one of the following special glazes to enhance your bread.

#### **Egg Glaze:**

Beat 1 large egg and 1 tablespoon of water together, brush generously over dough. (**Note:** Apply only to breads made using the dough setting just before baking.)

#### **Melted Butter Crust:**

Brush melted butter over just-baked bread for a softer, tender crust.

#### **Milk Glaze:**

For a softer, shiny crust, brush just-baked bread with milk or cream.

#### **Sweet Icing Glaze:**

Mix 1 cup sifted icing sugar with 1 to 2 tablespoons of milk to make a consistent glaze. Drizzle over Raisin Bread or Sweet Breads when almost cool.

**Poppy/Sesame/Caraway Seed:** Sprinkle your choice of these seeds generously over just-glazed bread.

# RECIPES - BASIC

## BASIC WHITE BREAD

	<b>1-Pound</b>	<b>1 1/2-Pound</b>	<b>2-Pound</b>
Water	3/4 cup	1 cup	1 1/4 cups
Oil	4 teaspoons	2 tablespoons	3 tablespoons
Sugar	4 teaspoons	2 tablespoons	3 tablespoons
Salt	1 teaspoon	1 1/2 teaspoons	2 teaspoons
Bread Flour	2 1/4 cups	3 cups	4 cups
RED STAR® Active Dry Yeast	1 1/2 teaspoons	2 1/4 teaspoons	1 tablespoon

Use **Basic** cycle 1, 2, or 3.

## RYE BREAD

	<b>1-Pound</b>	<b>1 1/2-Pound</b>	<b>2-Pound</b>
Water	3/4 cup	1 cup	1 1/4 cups
Oil	4 teaspoons	2 tablespoons	3 tablespoons
Caraway Seeds	2 teaspoons	1 tablespoon	5 teaspoons
Brown Sugar	4 teaspoons	2 tablespoons	3 tablespoons
Salt	1 teaspoon	1 1/2 teaspoons	2 teaspoons
Bread Flour	1 1/2 cups	2 cups	2 1/2 cups
Medium Rye Flour	3/4 cup	1 cup	1 1/2 cups
RED STAR® Active Dry Yeast	1 1/2 teaspoons	2 1/4 teaspoons	1 tablespoon

Use **Basic** cycle 1, 2, or 3.

## ONION BREAD

	<b>1-Pound</b>	<b>1 1/2-Pound</b>	<b>2-Pound</b>
Water	3/4 cup	1 cup	1 1/4 cups
Oil	4 teaspoons	2 tablespoons	3 tablespoons
Dry Onion Soup Mix	4 teaspoons	2 tablespoons	3 tablespoons
Sugar	2 teaspoons	1 tablespoon	4 teaspoons
Bread Flour	2 1/4 cups	3 cups	4 cups
RED STAR® Active Dry Yeast	1 1/2 teaspoons	2 1/4 teaspoons	1 tablespoon

Use **Basic** cycle 1, 2, or 3.

# RECIPES - BASIC

## CINNAMON RAISIN NUT BREAD

	<b>1-Pound</b>	<b>1 1/2-Pound</b>	<b>2-Pound</b>
Water	3/4 cup	1 cup	1 1/4 cups
Oil	4 teaspoons	2 tablespoons	3 tablespoons
Cinnamon	1/2 teaspoon	3/4 teaspoon	1 teaspoon
Dark Brown Sugar	2 teaspoons	1 tablespoon	4 teaspoons
Salt	1 teaspoon	1 1/2 teaspoons	2 teaspoons
Bread Flour	2 1/4 cups	3 cups	4 cups
Raisins*	1/3 cup	1/2 cup	2/3 cup
Nuts*	1/3 cup	1/2 cup	2/3 cup
RED STAR® Active Dry Yeast	1 1/2 teaspoons	2 1/4 teaspoons	1 tablespoon

Use **Basic** cycle **1, 2, or 3**.

\*Add raisins and nuts at beep during kneading.

## EGG BREAD

	<b>1-Pound</b>	<b>1 1/2-Pound</b>	<b>2-Pound</b>
Water	1/2 cup	1/2 cup	2/3 cup
Egg(s)	1	2	3
Oil	1 tablespoon	2 tablespoons	3 tablespoons
Sugar	1 tablespoon	2 tablespoons	3 tablespoons
Salt	1 teaspoon	1 1/2 teaspoons	2 teaspoons
Bread Flour	2 1/4 cups	3 cups	4 cups
RED STAR® Active Dry Yeast	1 1/2 teaspoons	2 1/4 teaspoons	1 tablespoon

Use **Basic** cycle **1, 2, or 3**.

## HONEY OATS BREAD

	<b>1-Pound</b>	<b>1 1/2-Pound</b>	<b>2-Pound</b>
Water	3/4 cup	1 cup	1 1/3 cups
Oil	4 teaspoon	2 tablespoons	3 tablespoons
Honey	2 tablespoons	3 tablespoons	1/4 cup
Salt	1/2 teaspoon	1 teaspoon	1 1/2 teaspoons
Oatmeal	1/3 cup	1/2 cup	3/4 cup
Oat Bran	3 tablespoons	1/4 cup	1/3 cup
Whole Wheat Flour	1/3 cup	1/2 cup	3/4 cup
Bread Flour	1 1/2 cups	2 cups	2 1/2 cups
RED STAR® Active Dry Yeast	1 1/2 teaspoons	2 1/4 teaspoons	1 tablespoon

Use **Basic** cycle **1, 2, or 3**.

# RECIPES - WHOLE WHEAT

## 100% WHOLE WHEAT BREAD

	<b>1 1/2-Pound</b>	<b>2-Pound</b>
Water	1 cup	1 1/3 cups
Oil	1 tablespoon	4 teaspoons
Honey	1/4 cup	1/3 cup
Salt	1 teaspoon	1 1/4 teaspoons
Whole Wheat Flour	3 cups	4 cups
RED STAR®		
Active Dry Yeast	1 tablespoon	4 teaspoons

Use **Whole Wheat** cycle **4 or 5**.

## SHREDDED WHEAT BREAD

	<b>1 1/2-Pound</b>	<b>2-Pound</b>
Water	1 cup	1 1/3 cups
Oil	3 tablespoons	1/4 cup
Molasses	3 tablespoons	1/4 cup
Salt	1 teaspoon	1 1/2 teaspoons
Bread Flour	1 cup	1 1/3 cups
Whole Wheat Flour	2 cups	2 2/3 cups
Mini-Shredded Wheat	1 cup	1 1/3 cups
RED STAR®		
Active Dry Yeast	1 tablespoon	4 teaspoons

Use **Whole Wheat** cycle **4, 5 or 6**.

## TRIPLE WHEAT BREAD

	<b>1 1/2-Pound</b>	<b>2-Pound</b>
Cold Water	1 1/4 cups	1 3/4 cups
Oil	2 tablespoons	3 tablespoons
Dark Molasses	3 tablespoons	1/4 cup
Salt	1 teaspoon	1 1/2 teaspoons
Bread Flour	1 1/2 cups	2 cups
Cracked Wheat	1/4 cup	1/3 cup
Wheat Bran	1/2 cup	2/3 cup
Wheat Germ	1/2 cup	2/3 cup
Whole Wheat Flour	1 1/2 cups	2 cups
RED STAR®		
Active Dry Yeast	1 tablespoon	4 1/2 teaspoons

Use **Whole Wheat** cycle **5**.

# RECIPES - WHOLE WHEAT•FRENCH•SWEET

## PUMPERNICKEL BREAD

	<b>1 1/2-Pound</b>	<b>2-Pound</b>
Water	1 cup	1 1/4 cups
Oil	4 teaspoons	2 tablespoons
Molasses	4 teaspoons	2 tablespoons
Sugar	4 teaspoons	2 tablespoons
Salt	1 1/2 teaspoons	2 teaspoons
Medium Rye Flour	1/3 cup	1/2 cup
Whole Wheat Flour	1 cup	1 1/3 cups
Bread Flour	1 3/4 cups	2 1/3 cups
Unsweetened Cocoa	4 teaspoons	2 tablespoons
Instant Coffee	1 1/2 teaspoons	2 teaspoons
RED STAR®		
Active Dry Yeast	2 1/4 teaspoons	1 tablespoon

Use **Whole Wheat** cycle **4, 5 or 6**.

## FRENCH BREAD

	<b>1 1/2-Pound</b>
Water	1 cup
Sugar	2 teaspoons
Salt	1 teaspoon
Bread Flour	3 cups
RED STAR® Active Dry Yeast	2 teaspoons

Use **French** cycle **7**.

## HOLIDAY BREAD

	<b>1-Pound</b>	<b>1 1/2-Pound</b>	<b>2-Pound</b>
Water	1/4 cup	1/2 cup	2/3 cup
Milk	1/2 cup	2/3 cup	1 cup
Oil	1 tablespoon	2 tablespoons	3 tablespoons
Salt	1 1/2 teaspoons	2 teaspoons	2 1/2 teaspoons
Sugar	3 tablespoons	1/4 cup	1/3 cup
Bread Flour	2 cups	3 1/3 cups	4 cups
Candied Fruit	1/3 cup	1/2 cup	2/3 cup
Walnuts, chopped	1/3 cup	1/2 cup	2/3 cup
RED STAR®			
Active Dry Yeast	1 1/2 teaspoons	2 1/4 teaspoons	1 tablespoon

Use **Sweet** cycle **8**.

# RECIPES - DOUGH

## TIPS FOR MAKING DOUGH

- The DOUGH setting is great for mixing, kneading, and proofing (allowing dough to rise) richer dough like croissant doughs. Use the bread machine to prepare this dough so all you need to do is shape and bake it according to your recipe.
- When recipes call for a "lightly floured surface," use about 1 to 2 tablespoons of flour on the surface. You may also want to lightly flour your fingers or rolling pin for easy dough manipulation.
- When you let dough "rest" and "rise" according to a recipe, place it in a warm, draft-free area. If the dough doesn't double in size, it may not produce a tender product. Dough is ready when an indentation remains when it is touched.
- If the dough you are rolling shrinks back, let it rest covered for a few minutes before rolling again.
- Dough may be wrapped in plastic and stored in a freezer for later use. Bring the dough to room temperature before using.

## CINNAMON ROLLS

### Dough

Water	1/2 cup
Eggs	2
Oil	2 tablespoons
Sugar	2 tablespoons
Salt	1 1/2 teaspoons
Bread Flour	3 cups
RED STAR® Active Dry Yeast	2 1/4 teaspoons

### Filling

Dark Brown Sugar	1 tablespoon
Butter, softened	3 tablespoons
Cinnamon	2 1/2 teaspoons

### Icing

Butter, softened	3 tablespoons
All-Purpose Flour	2 teaspoons
Powdered Sugar	1/3 cup
Vanilla	1 teaspoon
Water	about 2 tablespoons

Use **Dough** cycle **9**.

Divide dough into 2 parts. On lightly floured surface, roll half into a 12- x 9-inch rectangle. Combine **Filling** ingredients and sprinkle half evenly over dough. Starting with longer side, roll up tightly. Pinch edge to seal. Cut into 12 slices. Place on greased cookie sheet or cake pan. Repeat with remaining half of dough. Cover; let rise until indentation remains after touching the side of a roll. Bake in preheated 350°F oven 20 to 25 minutes. Remove from cookie sheets. Combine **Icing** ingredients adding only enough water to be smooth. Drizzle over warm rolls. Makes 24 rolls.

# RECIPES - DOUGH

## BAGELS

Water	1 cup
Sugar	3 tablespoons
Salt	1 1/2 teaspoons
Bread Flour	3 cups
RED STAR® Active Dry Yeast	2 1/4 teaspoons

Use **Dough** cycle 9.

### Hand Shaping:

Bring 3 quarts water to boil in a large pot. Stir in 1 table-spoon barley malt syrup.

Place dough on a lightly floured surface. Let dough rest for 5 minutes.

Cut dough into 9 equal pieces. Roll each into a smooth ball (1). Flatten balls, and poke a hole in the middle of each with your thumb (2). Next twirl the dough to enlarge the hole and even out the dough around it. Cover bagels with a clean cloth, and let rest for 10 minutes.

With a large metal spatula, carefully transfer bagels to boiling water, three at a time (3). Let boil for 1 minute, turning bagels over midway. Remove bagels from water with a slot-ted spoon and drain briefly on a clean towel. Transfer drained bagels to baking sheets sprinkled with cornmeal, four to five bagels per sheet.

If desired, glaze tops of bagels with egg white and sprinkle with poppy or sesame seeds, coarse salt and/or reconstituted dry onions (4). Bake bagels in 375°F preheated oven for 20 to 25 minutes, until well-browned.

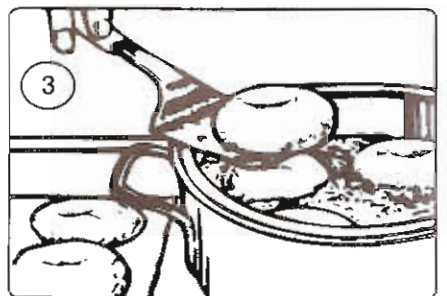
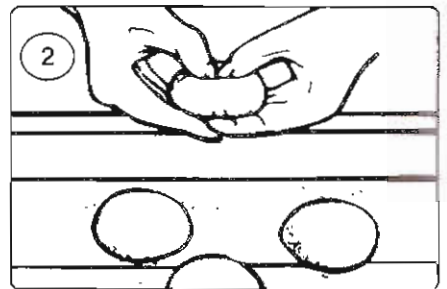
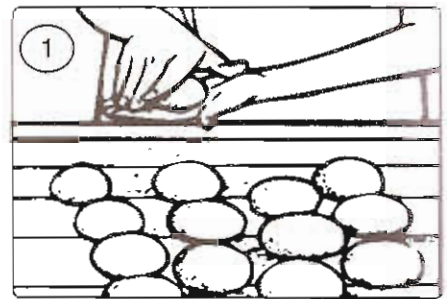



# RECIPES - DOUGH

## FRENCH BAGUETTES

Water	1 cup
Sugar	2 teaspoons
Salt	1 teaspoon
Bread Flour	3 cups
RED STAR® Active Dry Yeast	2 teaspoons

Use **Dough** cycle **9**.

### Hand Shaping:

Place dough on a lightly floured surface. Let dough rest for 5 minutes.

Cut dough into halves. Roll each portion into a long rope and place in trough of a lightly greased, double-trough baguette pan (maximum 3-inch wide trough) or on a lightly greased cookie sheet.

Glaze each baguette with egg white. Slash 5 times diagonally with a very sharp knife or pair of scissors. Place in a warm, draft-free spot to rise until doubled in size, about 45 to 60 minutes.

Glaze unslashed portions again with egg white. Bake in a 400°F preheated oven for 25 to 30 minutes, until deep brown.

---

## BREADSTICKS

Water	1 cup
Oil	2 tablespoons
Sugar	1 tablespoon
Salt	1 teaspoon
Bread Flour	3 cups
RED STAR® Active Dry Yeast	2 1/4 teaspoons

Use **Dough** cycle **9**.

### Hand Shaping:

Place dough on lightly floured surface. Let dough rest for 5 minutes.

With a lightly floured rolling pin, roll dough into a 1/4-inch thick rectangle. Square off edges.

Cut into 8-inch long by 1/4-inch wide strips. Carefully place on a lightly greased baking sheet, allowing 1/2-inch between each breadstick.

Bake in 375°F preheated oven for 15 to 20 minutes, or until golden brown.

**Optional Toppings:** Brush the surface with egg wash. Sprinkle lightly with grated cheese (Parmesan or cheddar) or desired seed, herbs or spices.

# RECIPES - DOUGH

## RICH SWEET BREAD

Water	1/2 cup
Eggs	2
Oil	2 tablespoons
Sugar	2 tablespoons
Salt	1 1/2 teaspoons
Bread Flour	3 cups
Raisins	1/2 cup
RED STAR® Active Dry Yeast	2 1/4 teaspoons

Use **Dough** cycle **9**.

### Hand-Shaping:

Place dough on a lightly floured surface. Divide dough into thirds. Roll each portion into a 14-inch rope. Place ropes side-by-side on a greased baking sheet. Braid ropes and tuck ends under securely. Cover and place in a warm, draft-free spot to rise for 45 to 60 minutes or until doubled in size.

Brush braid with egg white. Bake in preheated 375°F oven for 25 to 30 minutes, until deep golden brown.

---

## PIZZA CRUST

Water	3/4 cup
Olive Oil	2 tablespoons
Salt	1 teaspoon
Bread Flour	2 1/2 cups
RED STAR® Active Dry Yeast	1 1/2 teaspoons

Use **Dough** cycle **9**.

Divide dough into 2 parts. On lightly floured surface, roll or pat dough into a 12-inch circle. Place on greased pizza pan. Prick dough with fork. Bake in preheated 400°F oven 12 to 15 minutes or until crust is lightly browned. Remove from oven and spread/sprinkle with favorite pizza toppings. Return to oven for 10 to 15 minutes or until toppings are bubbling and/or melted.

### VARIATIONS

- Substitute 1/2 to 1 cup whole wheat flour for same amount of bread flour.
- Add 1 tablespoon crushed herbs (oregano, Italian spices, etc.) to ingredients just before adding oil.
- Add 1 cup grated or shredded cheese (Parmesan, Romano, Cheddar, pepper jack) to ingredients just before adding oil.

## RECIPES - CAKE/QUICK BREAD

### APPLE WALNUT LOAF\*

Eggs	2
Oil	3 tablespoons
Sugar	3/4 cup
Granny Smith Apples, peeled and grated	1 1/2 cups
Walnuts, chopped	3/4 cup
All-Purpose Flour	2 1/4 cups
Baking Soda	3/4 teaspoon
Baking Powder	1/4 teaspoon
Salt	1/4 teaspoon
Nutmeg	1/4 teaspoon
Cinnamon	1/2 teaspoon

Use **Cake/Quick Bread** cycle **10**.

### BANANA NUT BREAD\*

Oil	1/4 cup
Bananas, ripe and mashed	1 1/2 cups
Eggs	2
Sugar	1/2 cup
Dark Brown Sugar, packed	1/2 cup
Walnuts, chopped	3/4 cup
All-Purpose Flour	3 cups
Baking Powder	2 teaspoons
Baking Soda	1 teaspoon
Salt	1 1/2 teaspoons

Use **Cake/Quick Bread** cycle **10**.

### IRISH SODA BREAD\*

Buttermilk	1 cup
Egg	1
Caraway Seeds	2 teaspoons
All-Purpose Flour	3 cups
Sugar	1/3 cup
Baking Soda	1 1/2 teaspoons
Salt	1/2 teaspoon
Raisins	3/4 cup

Use **Cake/Quick Bread** cycle **10**.

## RECIPES -CAKE/QUICK BREAD

### CORN BREAD\*

Milk	1 cup
Eggs	2
Oil	1/3 cup
Sugar	1/4 cup
All-Purpose Flour	2 2/3 cups
Cornmeal	1 cup
Baking Powder	1 tablespoon

Use **Cake/Quick Bread** cycle **10**.

### CARROT PECAN BREAD\*

Milk	2/3 cup
Butter/Oil	1/4 cup
Eggs	2
Carrots, finely grated	1 1/2 cups
Sugar	1/3 cup
Dark Brown Sugar, packed	1/3 cup
All-Purpose Flour	2 1/4 cups
Baking Powder	3/4 teaspoon
Baking Soda	3/4 teaspoon
Salt	1/4 teaspoon
Cinnamon	3/4 teaspoon
Nutmeg	1/4 teaspoon
Pecans, chopped	3/4 cup

Use **Cake/Quick Bread** cycle **10**.

### CHOCOLATE CHIP ZUCCHINI BREAD\*

Buttermilk	1/3 cup
Eggs	3
Butter/Oil	3 tablespoons
Zucchini, grated unpeeled	1 1/2 cups
Light Brown Sugar	3/4 cup
All-Purpose Flour	2 1/4 cups
Baking soda	1 1/2 teaspoons
Salt	1 1/2 teaspoons
Miniature Chocolate Chips	1 cup

Use **Cake/Quick Bread** cycle **10**.

\*To insure flour is completely blended, scrape pan with rubber scraper during mixing.

## RECIPES - QUICK BREAD/CAKE•JAM

### CAKE-MIX CAKE

*A delicious, fast and easy cake that's great with ice cream.*

- 1 1/3 cup water
- 3 egg whites
- 1/2 cup oil
- 1 cake mix (18-20 ounce size, yellow, white or chocolate)

Place ingredients in bread pan in the order listed. Select setting 10 (Cake/Quick Bread).

When cycle is completed, remove pan from machine. Let cake sit in pan for 20-30 minutes. Gently shake cake out of pan; place on a wire rack, bottom down. Cool completely, about one hour.

Use **Cake/Quick Bread** cycle **10**.

---

### STRAWBERRY JAM

- 1 20-ounce package frozen, unsweetened strawberries\*, crushed and thawed
- 1 1.75-ounce package dry pectin
- 3 1/2 cups sugar

Place ingredients in bread pan in the order listed. In jam-making, sugar needs to dissolve completely. If necessary, use a rubber spatula to stir ingredients.

When cycle is completed, remove pan from machine. Mixture will be VERY HOT.

Using a metal spoon, skim off and discard foam from top. Pour jam into sterilized jars or containers. Refrigerate or freeze.

Use **Jam** cycle **11**.

\* For other fruit-flavored jams, substitute desired frozen fruit for the strawberries. Follow same basic recipe.

# TROUBLESHOOTING

## CHECKING DOUGH CONSISTENCY

When experimenting with recipes or using new breadmaker recipes, it is always a good idea to check your dough consistency. After 5 minutes of kneading, open the lid of the bread machine and check the dough consistency. The dough should form a soft, tacky ball. If too dry, add liquid; if too wet, add flour -- 1/2 to 1 tablespoon at a time.

## CRATERED BREAD

If the top of your loaf caves in, this is a sign of too much moisture. You may need to make recipe adjustments, such as reducing liquid or adding flour, 1/2 to 1 tablespoon at a time. Cratered bread may also happen with cheese bread because each cheese has its own moisture content.

## MUSHROOM BREAD

Mushroom bread may be caused by too much yeast or too much water. Also, you may be using too much dough for your pan size. Check your recipe to make sure the total amount of flour does not exceed 4 1/3 cups.

## GNARLY LOAVES

Your dough probably needs more moisture. See "Checking Dough Consistency", above.

## HIGH-ALTITUDE BAKING

In high-altitude areas, doughs tend to rise faster as there is less air pressure. Therefore, less yeast is necessary. In dry climates, flour is drier, requiring slightly more liquid. In humid climates, flour is wetter and will absorb less liquid; slightly more flour may be required.

## JAM

If you find that your jam is not thick enough, repeat the Jam cycle.

## THE SCIENCE OF BREADMAKING

Most recipes contain sugar in some form for sweetness. In breadmaking, sugar helps start or "feed" the yeast and promotes browning. Salt, on the other hand, inhibits the yeast, but also adds flavor. With this knowledge in mind, you can control the balance of the chemical reaction between flour, yeast, water, sugar and salt to make a perfect loaf of bread. The recipes included with this booklet have been tested to work in this bread machine. When using recipes from other sources, you may have to make adjustments for perfect results. Follow suggestions from this guide.

## NEED HELP?

### QUESTIONS ABOUT GENERAL PERFORMANCE AND OPERATION

<b>Q1</b> How do I make doughnuts using my bread machine?	<b>A1</b> Use the dough setting to make the dough for the doughnuts. Then shape and fry the doughnuts in a conventional deep fryer.
<b>Q2</b> What should I do if the kneading blade comes out with the bread?	<b>A2</b> Remove it with a crochet hook or a sandwich pick before slicing the bread. Since the blade can be separated from the pan, it is not a malfunction if it comes out in your bread.
<b>Q3</b> Why does my bread sometimes have some flour on the side crust?	<b>A3</b> Your dough may be too dry. Next time, check your recipe and measuring. You may need to add more liquid, 1/2 to 1 tablespoon at a time. You can simply trim off that portion of the outer crust.
<b>Q4</b> Why isn't the dough mixing? I can hear the motor running.	<b>A4</b> The kneading blade or baking pan may not be inserted properly. Make sure the pan is facing the right way and that it has clicked into place.
<b>Q5</b> How long does it take to make bread?	<b>A5</b> See cycle times chart, page 12.
<b>Q6</b> Why can't I use the timer when baking with fresh milk?	<b>A6</b> The milk will spoil if left sitting in the machine too long. Perishable ingredients, such as eggs and milk, should never be used with the timer feature.
<b>Q7</b> If the power goes out in the middle of a cycle, will my bread machine finish baking bread or making dough?	<b>A7</b> No. Discard the unfinished bread or dough, or finish process by hand and bake in your own oven. The bread machine will only start at the beginning of the cycle.
<b>Q8</b> Why do I have to add the ingredients in a certain order?	<b>A8</b> This allows the bread machine to mix the ingredients in the most efficient manner possible. When using the timer, it also keeps the yeast from combining with the liquid before the dough is mixed.
<b>Q9</b> When setting the timer for morning, why does the machine make sounds late at night?	<b>A9</b> The machine must start operation several hours before the bread will be ready. These sounds are made by the motor when kneading the dough. It is a normal operation, not a malfunction.
<b>Q10</b> What size loaf does the bread machine make?	<b>A10</b> Your Bread maker makes REGULAR (1 lb.), LARGE (1 1/2 lb.) and EXTRA LARGE (2 lb.) loaves of bread.
<b>Q11</b> The kneading blade is stuck in the bread pan after baking. How do I get it out?	<b>A11</b> If the kneading blade gets stuck, pour warm water into the bread pan; rotate the kneading blade to clean under it.

# NEED HELP?

## QUESTIONS ABOUT GENERAL PERFORMANCE AND OPERATION

<b>Q12</b> How many watts is my bread machine?	<b>A12</b> 630 watts during the baking cycle. Very little power is consumed during the kneading and rising cycles.
<b>Q13</b> Can I wash the baking pan in the dishwasher?	<b>A13</b> No. The baking pan and kneading blade must be washed by hand. Do not immerse the pan in water.
<b>Q14</b> What will happen if I leave the finished bread in the baking pan?	<b>A14</b> This may result in soggy bread as excess steam (moisture) would not be able to escape. For best results, cool the loaf on a wire rack after baking.
<b>Q15</b> Why did the dough only partially mix?	<b>A15</b> Check to make sure the kneading blade and baking pan is inserted properly. Also, check the dough consistency. After 5 minutes of kneading, check dough. If too dry, add liquid; if too moist, add flour. (Only add 1/2 to 1 tablespoon at a time.)
<b>Q16</b> Why didn't the bread rise?	<b>A16</b> The yeast could be old or expired, or possibly no yeast was added at all. Check to see if your yeast is fresh. Also, check the dough consistency. After 5 minutes of kneading, check dough. If too dry, add liquid; if too moist, add flour. (Only add 1/2 to 1 tablespoon at a time.)
<b>Q17</b> Why can't the delayed finish be set for more than 12 hours? What is the minimum time a cycle may be delayed?	<b>A17</b> The maximum length of delay is 12 hours, including the particular cycle time. For example, setting 8 has a cycle that takes 3 hours 25 minutes, so it may be delayed up to 8 1/2 hours. The minimum length of delay for each setting is 10 minutes.

## QUESTIONS ABOUT INGREDIENTS/RECIPES

<b>Q18</b> How do I know when to add raisins, nuts, etc., to the bread?	<b>A18</b> On settings 1 thru 3 and 8, the Fruit & Nut beep signals when to add raisins, nuts, etc. (NOTE: The beep sounds after 32 minutes.) If it is more convenient for you to add them at the start, you will still have acceptable results. However, the added ingredients may be broken apart during kneading.
<b>Q19</b> My baked bread is too moist? What can I do?	<b>A19</b> Humidity may affect the dough. After 5 minutes of kneading, check the dough consistency. If it appears too moist, add more flour 1/2 to 1 tablespoon at a time. For best results, remove the baked bread from the pan soon after the baking is completed.



## NEED HELP?





### QUESTIONS ABOUT INGREDIENTS / RECIPES

<b>Q20</b> Why do I get air bubbles at the top of the bread?	<b>A20</b> This can be caused by using too much yeast.
<b>Q21</b> When using raisins, the bread machine crushes them. How can I avoid this?	<b>A21</b> Add raisins, nuts etc., at the Fruit and Nut beep, approximately 32 minutes into the cycle. For best results, use dry raisins. Also check your dough consistency 5 minutes into kneading. If the dough is too dry, it will not incorporate the raisins easily.
<b>Q22</b> Why does my bread rise and then collapse or crater?	<b>A22</b> The bread may be rising too fast. To reduce the rate of rising, reduce the amount of water and/or increase the amount of salt and/or decrease the amount of yeast. (See Baking Tips Guide on pages 33 and 34.)
<b>Q23</b> Can I use my favorite bread recipes (traditional yeast bread) in my bread machine?	<b>A23</b> Yes, but you will need to experiment to get the right proportion of ingredients. Become familiar with the unit and make several loaves of bread before you begin experimenting. Never exceed a total amount of 4 1/3 cups dry ingredients. Use the recipes in this book to help determine the ratio of flour to liquid and amounts of yeast, sugar, salt and fat to use.
<b>Q24</b> Why do the loaves vary in height and weight? The whole wheat and multi-grain breads are always shorter. Am I doing something wrong?	<b>A24</b> No, it is normal for Whole Wheat and Multi-Grain breads to be shorter and denser than Basic or French breads. Whole Wheat and Rye flours are heavier than white bread flour, therefore they don't rise as much during the bread making process. They also typically have added ingredients, such as oats, bran, nuts and raisins, which contribute to the shorter height and denser texture.

### BAKING TIPS INTRODUCTION

When developing Welbilt® Bread Machine recipes, hundreds of loaves of bread were baked using the most popular brands of flours and yeasts available. If you use flour processed by a local mill it may have different characteristics and produce different results than popular national brands. If you followed the recipe in the cookbook exactly and feel the results should be better, use the BAKING TIPS on the following pages to help you produce a better loaf of bread. Usually, there are several ways to improve baking results. We recommend you **make adjustments one at a time**. Also, keep track of your adjustments to know what changes were made to create your perfect loaf.

# BAKING TIPS FOR YEAST BREADS

RESULTS		Loaf Rises Then Falls: "Cratered Loaf"	Loaf Sides Caved In	Loaf Rises Too High: "Mushroom Loaf"	Loaf Does Not Rise Enough	Flat Loaf, No Rising, Short and Heavy	Crust Too Dark	Crust Too Light	Undercooked Or Fully Cooked
									
POSSIBLE SOLUTIONS									
MEASUREMENT	Water or Milk	Increase +			1 Tbsp.				
	Milk	Decrease -	1 Tbsp.	1 Tbsp.	1 Tbsp.			2 Tbsp.	
	Salt	Increase +	1/4 tsp.	1/4 tsp.	1/4 tsp.				
		Decrease -				1/4 tsp.			
	Sugar or Honey	Increase +				1/2 Tbsp.			1/2 Tbsp.
		Decrease -			1/2 Tbsp.			1/2 Tbsp.	
	Flour	Increase +							
		Decrease -			1 Tbsp.				
	Yeast	Increase +				1/8-1/4 tsp.			
Decrease -		1/8-1/4 tsp.	1/8-1/4 tsp.	1/8-1/4 tsp.					
INGREDIENT	Water or Milk	Not enough added			●				
		Too hot or too cold				●	see p.17		
	Flour	Old, out of date				●	●		
		Low in gluten content				●	●	see pp.13,14	
		Too fine	●			●	●	see pp.13,14	
	Yeast	None was added					●		
		Out of date code					●	see p.15	
		Used wrong type (fresh) instead of dry granular			●	●	●	see p.15	
	Salt	Not added			●				
		Too much was added				●	●		

# BAKING TIPS FOR YEAST BREADS

Overcooked	Not Mixed or Partially Mixed	Loaf is Soggy	Gnarly Knotted Top	Open, Coarse, or Uneven Texture	Heavy, Dense Texture	Burning Odor During Operation	High Altitude Adjustment	Breadmaker Cannot be Programmed or Started	Loaf Burned Completely
			1 Tbsp.						
							2 Tbsp.		
				1/4 tsp.					
					1/2 Tbsp.				
12 Tbsp.							1/2 Tbsp.		
			1 Tbsp.		1 Tbsp.				
				1/8-1/4 tsp.	1/8-1/4 tsp.		1/8-1/4 tsp.		
				1/8-1/4 tsp.					
	●		●						
	see pp.13,14 ●								
					see p.15 ●				
				●					

Hyacinth Hazel Mondesir Pemberton

**SPECIFICATIONS**

**MODEL: ABM6900**

POWER REQUIREMENT: 120V, 60Hz  
POWER CONSUMPTION:  
630 WATTS

MADE IN CHINA

Mikal Alexander Oluwemi

**WELBILT®**

**APPLIANCE CORP. OF AMERICA**  
**P.O. BOX 220707**  
**GREAT NECK, NY 11021**

4375

Surya Shinde Mondesir

If you have any problems with the unit, contact the  
**WELBILT CUSTOMER SATISFACTION CENTER**  
for assistance.

**Phone: 1-800-872-1656**

876-543-7911

Please read operating instructions before using this product.

Natalie Nicole Pemberton

Mikal Alexander Oluwemi