

@I-G c^f£miOM^an2AJtM,S^£xUL

r  
OHS.

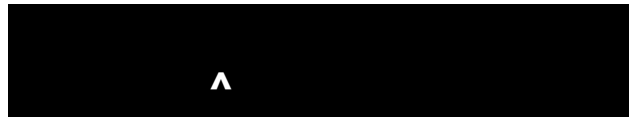
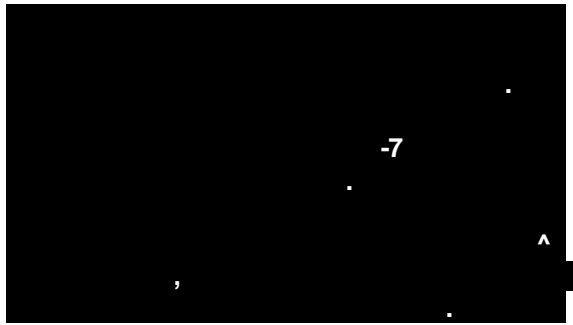

... Af

••w v.iy. -



HB-156JE



	<b>5</b>
	<b>6</b>
	<b>8-14</b>
•	8
•	10
•	11
•	13
•	14
	<b>15-17</b>
	<b>18-19</b>
	<b>20-24</b>
•	20
•	22
	<b>25-34</b>
•	«
»,	25
,	28
•	
•	«
,	»,
•	29
•	31
•	32
•	33

- 
- 

**34-36**  
35  
36

- ,
- , ...
- 
- 

**37-41**  
37  
38-39  
40  
41

**42**

**43-92**



(1)

7 , 250, 1750 (2)

!

680

10

3

3,5

. . . . . 5  
 . . . . . 3 : : , , , , ,  
 9 . , , , ( 8 , . , , -  
 ) . 5 ( -  
 . . ) , , , , ,  
 8 , : .



3 40



3 40





),

3 40  
(8 )

15

(2 , ).

3:25.

( -

).



4

86

).

(8 )

( 8 ,

1 41



(8 ) 14  
1:45.

1 59

8

1 03



13

4

10

3

/							
	4:10-13:00	4:10-13:00	4:10-13:00	4:10-13:00	4:10-13:00	4:10-13:00	-
	-	-	-	20	-	-	10
1-	7	7	7	13	7	6	-
	5	5	5	50	5	5	-
2-	12	12	12	12	7	12	-
1-	40	40	40	20	13	40	-
	4	4	4	4	4	4	-
2-	26	26	26	15	-	-	-
	4	4	4	4	-	-	-
3-	60	60	60	40	52	-	-
	50	50	50	50	35	-	60
	20	20	20	20	-	-	10
	3	3	3	3	3	-	-
	3:40	3:40	3:40	4:00	1:59	1:03	1:20



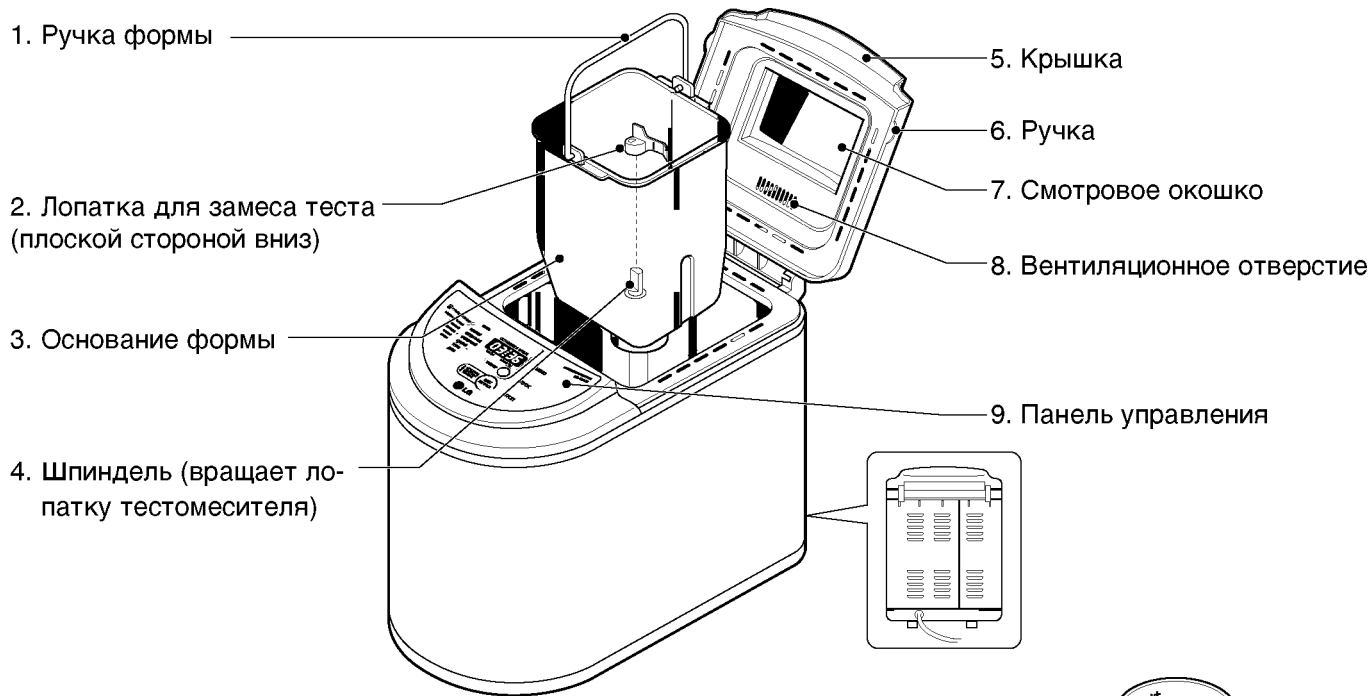

## Аксессуары:

Мерная чашка для жидкостей: объем - 230 мл

Столовая ложка: объем -15 гр.

Чайная ложка: объем -5 гр.

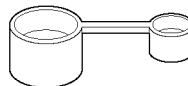

1.

2.

3.

4.

5.

6.

7.

8.

9.

1 7

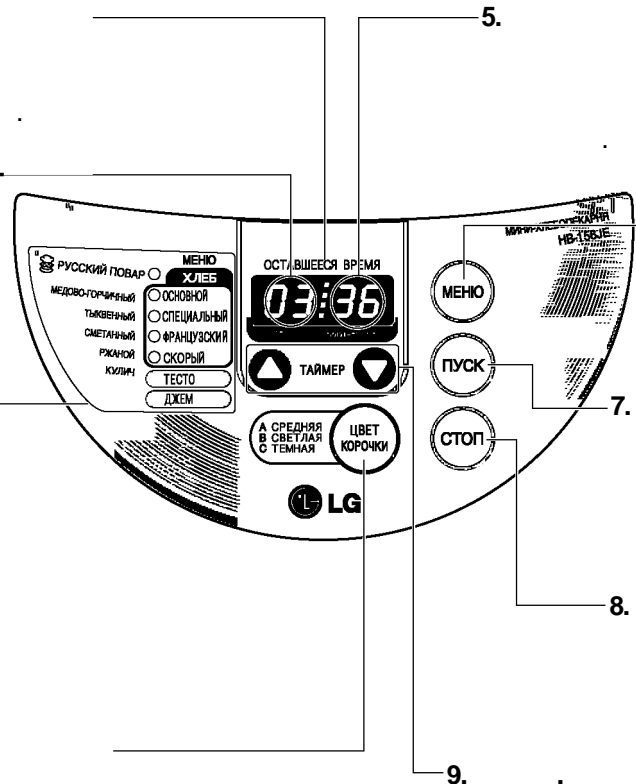

10

4:10 13:00.

1.

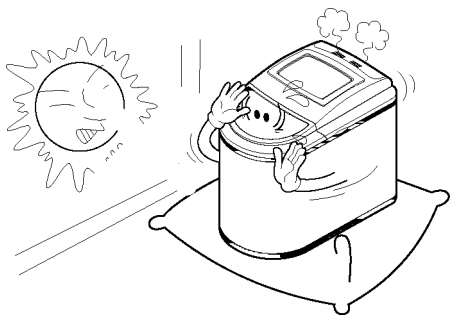

2.

10

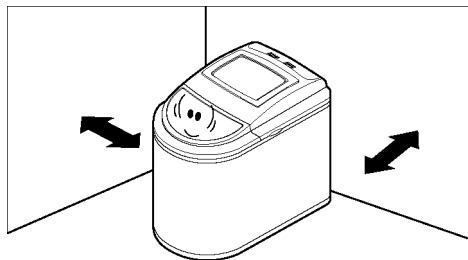

3.

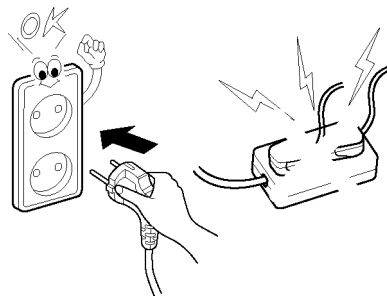

4.

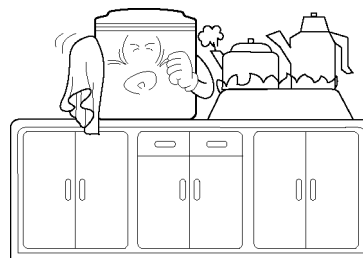

5.

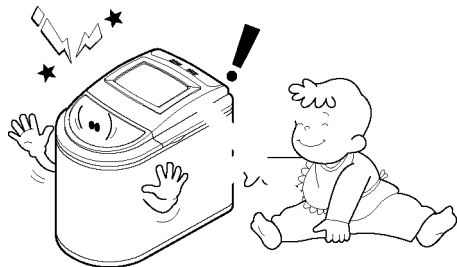

6.



7.

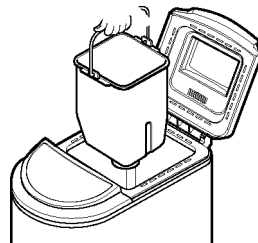

8.





9.

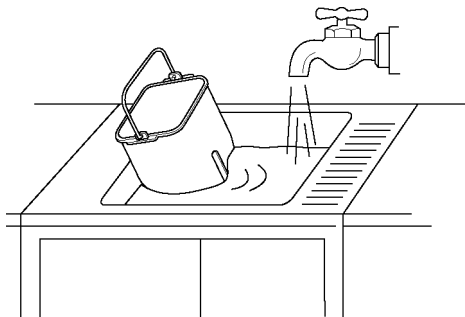

11.

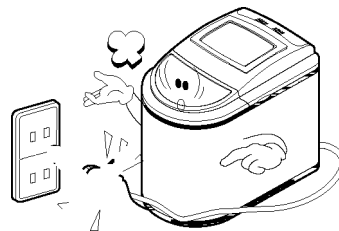

10.

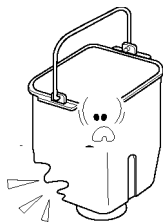

12.

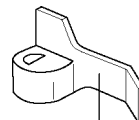

!

,

,

!

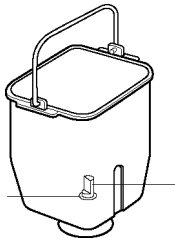

20.

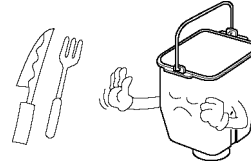
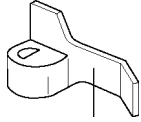



37,7

43-46

26,6

- 1/8

1/4

5

( , )

15%



450-700 . . . -



»,

,

,

«

1.

3.

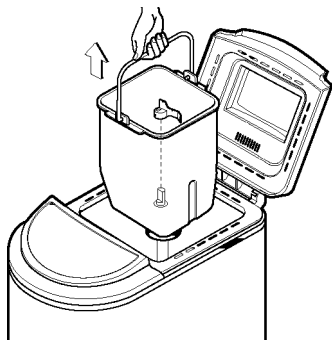

2.

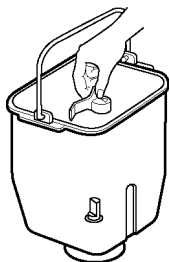

4.

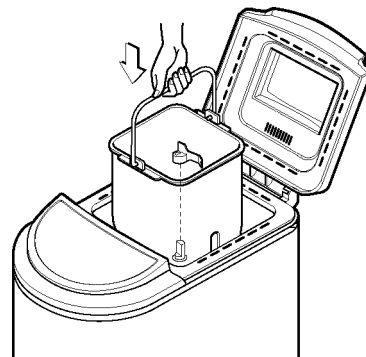

5.

:

-

7.

6.

(

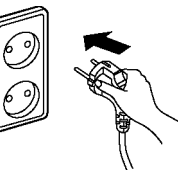

1:59).  
4:00,

: 3:40 (

20

ПУСК



:

8.

8

3

3

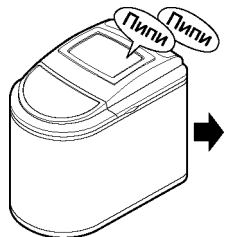

4

9.

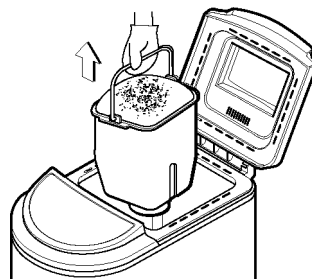

10.

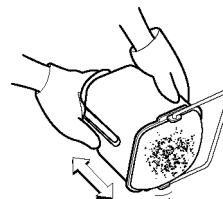

( , ) . “ ” , ,

( 4:10 13:00 10-

9:30, 9 6:30 9:30.

1. : « »



10



13

2.



« »,

3:40,



- 4:00,

- 1:59.

1:03.

3.



МЕНЮ



ПУСК



1.

2.

3.

4:00

, 1:59

15

3:25.

1:26

5

8

1:45.

14

2:34.

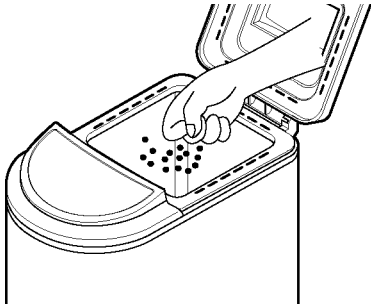

1.

\_\_\_\_\_  
• \_\_\_\_\_  
\_\_\_\_\_ 3



6:-



/ 03

2.

3.

4.

5.

« «

« «.

1:03,

1 03

- ТЕСТО
- ДЖЕМ

МЕНЮ

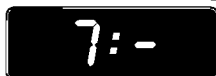

1.

2.

3.

20

•

•

•

•

•



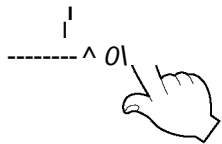

Λ

В  
^ СВЕТЛАЯ →

--	--

4, 6 8

3

,

.

:

,

6

8

.

.

,

.

-

-

-

-

-

-

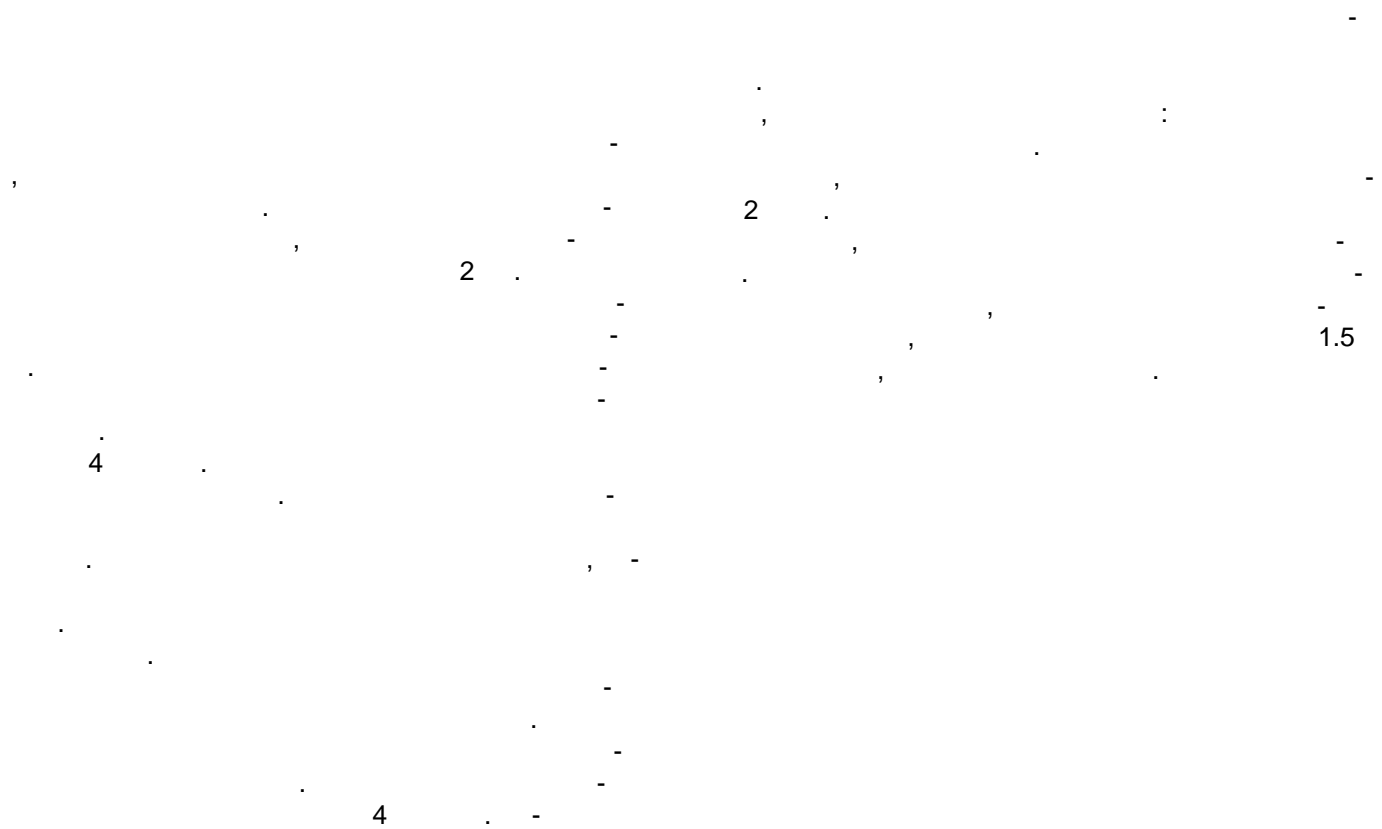

,

5

	<ul style="list-style-type: none"><li>• ( 30-40 ).</li><li>•</li><li>•</li><li>•</li></ul>
	<ul style="list-style-type: none"><li>• ( ).</li><li>•</li></ul>
	<ul style="list-style-type: none"><li>•</li></ul>
	<ul style="list-style-type: none"><li>• 3</li></ul>
	<ul style="list-style-type: none"><li>•</li></ul>
	<ul style="list-style-type: none"><li>• ( ).</li></ul>
	<ul style="list-style-type: none"><li>• ( ).</li></ul>
	<ul style="list-style-type: none"><li>•</li><li>•</li></ul>
	<ul style="list-style-type: none"><li>•</li><li>•</li></ul>

,

,

:

.....

7?

\_\_\_\_\_  
\_\_\_\_\_  
\_\_\_\_\_  
\_\_\_\_\_  
( \_\_\_\_\_ )  
\_\_\_\_\_

( \_\_\_\_\_ )  
\_\_\_\_\_  
\_\_\_\_\_  
\_\_\_\_\_  
\_\_\_\_\_  
\_\_\_\_\_  
\_\_\_\_\_

\_\_\_\_\_  
\_\_\_\_\_  
\_\_\_\_\_  
\_\_\_\_\_  
\_\_\_\_\_  
\_\_\_\_\_  
( \_\_\_\_\_ )

- - - - -

-

:

:

1.

?

1.

2.

?

2.

3.

?

3.

4.

?

4.

5.

13

?

5.

6.

?

6.

7.

?

7.



## Дисплей

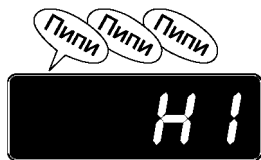

## Как перезапустить

Когда печь остынет, нажмите кнопку ПУСК и снова начните процесс.

Во время работы  
Хлебопекарни произошло  
отключение питания.

Очистите форму от теста  
и начните процесс заново.



		. <b>230 50</b>
		550
		100
		232x392x318
		7.3
		13
		1
		144 °
		135 °

, , , , )

		5.	680 . 70 .
1.	-	680 . 45 .	680 . 71 .
2.		680 . 46 .	7. « » 450, 680 . 72 .
3.		680 . 47 .	8. 680 . 73 .
4.		680 . 48 .	9. 680 . 74 .
5.		680 . 50 .	10. 680 . 75 .
			11. 680 . 76 .
			12. 680 . 77 .
1.		450, 680 . 51 .	
2.		450, 680 . 52 .	
3.		450, 680 . 53 .	1. 78 .
4.		450, 680 . 54 .	2. ( ) 79 .
5.		450, 680 . 55 .	3. ( ) 80 .
6.		450, 680 . 56 .	4. 81 .
7.		680 . 57 .	5. « » 82 .
8.		450, 680 . 58 .	6. « » 83 .
9.		680 . 59 .	7. 84 .
			8. 85 .
			9. 86 .
1.		450, 680 . 60 .	
2.		450, 680 . 61 .	
3.		680 . 62 .	1. 87 .
4.		680 . 63 .	2. 88 .
5.		680 . 64 .	3. 89 .
6.		680 . 65 .	4. 90 .
			5. 91 .
			6. 92 .
1.		450, 680 . 66 .	
2.		450, 680 . 67 .	
3.		680 . 68 .	
4.		680 . 69 .	

• , . -

• .

• .

• .

• .

• .

• .

• .

• .

-

:	680
	1
	3
	1
	1
	2
	2
	2
	2

« »

\* 1 ,

:

- 1.
- 2.
- 3.
- 4.
- 5.
- 6.
- 7.

:	680	« »
	0,75	*
	2	
	0,5	
	3,25	
	1,5	
	2	
	2	
	1	
	1	
	1,75	
	0,3	*

- 1.
- 2.
- 3.
- 4.
- 5.
- 6.
- 7.
- 8.

:	680	« »
25%	125 .	*    1
	0,5	
	3	
	1	
	3	
	2	
	2	
	0,3	

:

- 1.
- 2.
- 3.
- 4.
- 5.
- 6.
- 7.
- 8.

( )-  
:  
, 18 .

10-15 .

:	
	500 .
	3
	3
	1
:	<b>680</b> .
	1
	2
	2
	1
	0,25
	1
	1,5
	2
	2
	2
	1,5

, ,  
3  
-18  
« »  
\*  
(4  
0,25 , 5  
, ).







:	450 .	680 .
	3/4 2 .	1,25
	2	3,3
	1	1,5
	1,5	2
	1	2
	1	2
	1	1,5

- 1.
- 2.
- 3.
- 4.
- 5.
- 6.
- 7.

	680
1	1
	2,25
	3/4
	1
	2
	3
	2
( )	0,3
	2

- 1.
- 2.
- 3.
- 4.
- 5.
- 6.
- 7.

	<b>450</b> .	<b>680</b> .
2 , -	0,75	1 2
	2	3
	1	1.5
	1.5	2
	2	3
	1	2
	1.5	2.25

:

- 1.
- 2.
- 3.
- 4.
- 5.
- 6.
- 7.

:	450 .	680 .
	0,75 2 .	1 2 .
	2	3
	1	1,5
	2	3
	1,25	2

:

- 1.
- 2.
- 3.
- 4.
- 5.
- 6.
- 7.

:	<b>450</b> .	<b>680</b> .
	0,75	1      2    . .
	2	3
	1	2
	1	3
	1	1.5
	1	2
	0.25	0.3
	2	2,5

:

- 1.
- 2.
- 3.
- 4.
- 5.
- 6.
- 7.

:	<b>450</b> .	<b>680</b> .
1 , -	0,75	1 3 . .
	2 .	2 .
	1	1
	2 2 . .	3
	0,25	0,3
	1	1,5
	4	2 .
	0,15	0,25
	1 .	1,5 .
	1,5	2

:

- 1.
- 2.
- 3.
- 4.
- 5.
- 6.
- 7.



:	<b>450</b> .	<b>680</b> .
	0,75      2      . .	1      3      . .
	2	3
	1	1,5
	2 .	0,25
	1 .	2 .
	1 .	2 .
	1,5	2

:

- 1.
- 2.
- 3.
- 4.
- 5.
- 6.
- 7.

:	<b>450</b> .	<b>680</b> .
	0,75	1      2 . .
	2	3,25
	1	1,5
	2	3
	1	3
	1	2
(      )	1	2
	1,5	1,75

:

- 1.
- 2.
- 3.
- 4.
- 5.
- 6.
- 7.

:	<b>680</b> .
	1
	3
	1
	2
	2
	0,25
	1,5

- 1.
- 2.
- 3.
- 4.
- 5.
- 6.
- 7.

:	450 .	680 .
	0,75	1 2,5 . .
	2	3
	1	1,5
	2 .	3 .
	2 .	2,5 .
	1 .	1,5 .
	1	1,5 .
	2,5	1 .
	2	2,5

:

- 1.
- 2.
- 3.
- 4.
- 5.
- 6.
- 7.

:	450 .	680 .
	0,75 2 . .	1 2 . .
	2 2 . .	3
	1,5	1,5
	1	2
	3	0,25
	1	2
	0,5	0,75
	1,5	2

:

- 1.
- 2.
- 3.
- 4.
- 5.
- 6.
- 7.

:	680 .
1 , -	1 1 .
	3
	3
	1,5
	2
	1,5
	0,5
	2

:

- 1.
- 2.
- 3.
- 4.
- 5.
- 6.
- 7.

:	680 .
( .)	1
	3
	1,5
	3,5
	2
	2
	2
( )	0,3

:

- 1.
- 2.
- 3.
- 4.
- 5.
- 6.
- 7.
- 8.

:	680 .
	1
	3
	2
	1
	2
	2
( . )	0,5
	2

:

- 1.
- 2.
- 3.
- 4.
- 5.
- 6.
- 7.



:	680 .
1 , -	1 2 .
	3
	2
	1
	2
	2
	0,3
	0,25
	0,75
	2

:

1

- 1.
- 2.
- 3.
- 4.
- 5.
- 6.
- 7.

:	<b>450</b> .	<b>680</b> .
	0,75	1 2 . .
	2	3
	0,75	1
	2	3,5
	1	2
	1	2
	1	1,5
	1,25	2
	0,25	0,3
	0,25	0,5

:

- 1.
- 2.
- 3.
- 4.
- 5.
- 6.
- 7.
- 8.

( ) ,



:	680 .
	1 2
	3
	1
	2
	2
	2
	2

:

- 1.
- 2.
- 3.
- 4.
- 5.
- 8.
- 7.

:	680 .
	1
	3
	1
	1,5
	2
	2
	0,25
	2
	1
	1
	2

:

- 1.
- 2.
- 3.
- 4.
- 5.
- 6.
- 7.

:	680 .
	1 2 . .
	3
	2
	1,5
	2
	2
	2
	2
	0,25
	2

:

- 1.
- 2.
- 3.
- 4.
- 5.
- 6.
- 7.

:	<b>680</b> .
	1.25
	3
	0.75
	1
	0.25
	2
	3
	1
	2

:

- 1.
- 2.
- 3.
- 4.
- 5.
- 6.
- 7.

« »

:	450 .	680 .
	0.75 1 .	1 2 . .
	1.5	3
	0.75	1
	1	2
	2,5	3
	1	2
	1,5	2
	1,5	2
	0,25	0,5

:

- 1.
- 2.
- 3.
- 4.
- 5.
- 6.
- 7.
- 8.

( ),



# K

:	680 .
3,5%	1
	3
^ »	0,5
	1
	1
	2
	2
	1
	2
( )	0,5

1. :
2. , ( ) , .
3. .
4. .
5. .
6. .
7. .
8. , .

:	680 .
	1 2 .
	3
	1
	3,5
	2
	2
	2
	2
	0,5

1. :
2. , ( ) , .
3. .
4. .
5. .
6. .
7. .
8. , .

:	680 .
1 , -	1 2 .
	3
	0,75
	1
	3
	3
	0,5
	1
	2
	0,5

1. :
2. , .
3. .
4. .
5. .
6. .
7. .
8. , .



:	<b>680</b> .
	1
	3
	1
	2
	2
	2
	2
	0,3

1. :
2. , .
3. .
4. .
5. .
6. .
7. .
8. , .

:	:
1 , -	1
	3
	1

1. :
2. .
3. .
4. , .
5. .
6. .
7. .

( )

:	:
1 , -	3/4
	2
	6
	2,5
	0,5
	0,5

- 1.
- 2.
- 3.
- 4.
- 5.
- 6.
- 7.
- 8.
- 9.

220°

20-25

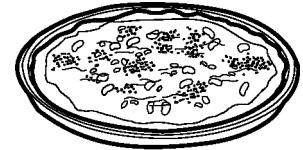
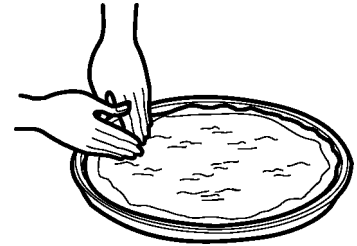

( )

:	:
	1
	3
	1
	1
	2
	1,75

1. :
2. :
3. :
4. :
5. :
6. 20 ,
7. 220° 35 - 45

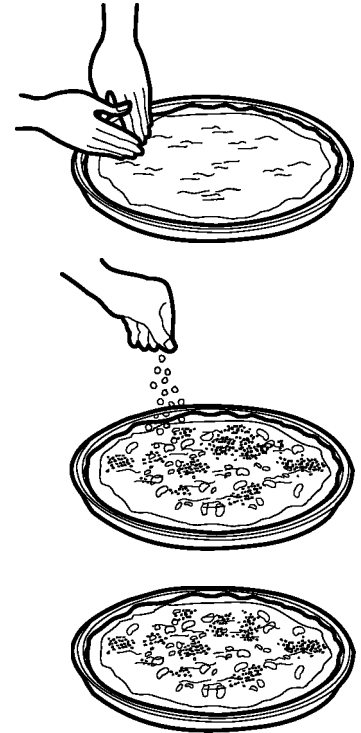



9

180°

:	:
	0,75
	1
	3
	0,3
	1
	1
	2,5
:	:
	0,75
	0,5
	0,5
	0,3
	0,25

- 1.
- 2.
- 3.
- 4.
- 5.
- 6.
- 7.
- 8.
- 9.
- 10.
- 11.
- 12.
- 13.
- 14.

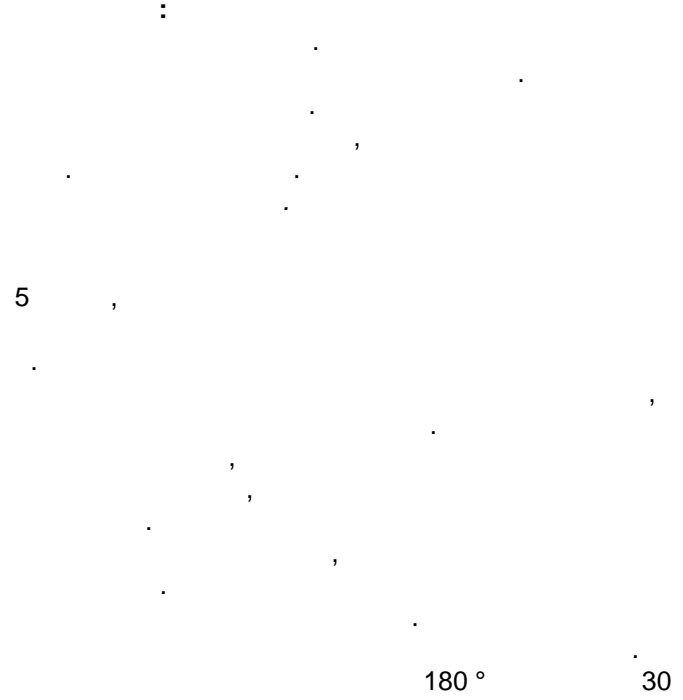

- 15.
- 16.

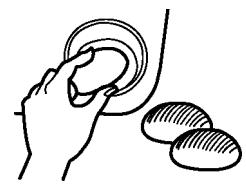
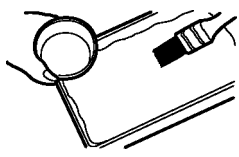
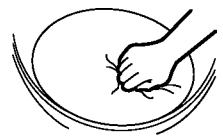

« »

680

180°

:	:
	1 2 . .
	2 .
	3,5
	2
	1
	2
	0,5
	2,5
:	:
	2
	0,25
	0,5
:	:
	1
	2
	2
	2

- 1.
- 2.
- 3.
- 4.
- 5.
- 6.
- 7.
- 8.
- 9.
- 10.
- 11.
- 12.
- 13.
- 14.
- 15.
- 16.
- 17.
- 18.

30-35

180°

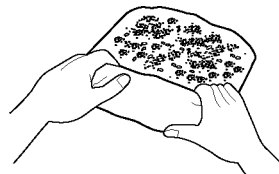
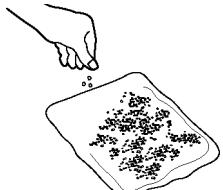

« »

680

220°

:	:
	1
	3
	1
	2
	2
:	:
	0,5
	0,5
	0,25
	0,75
	2 . . .

- 1.
- 2.
- 3.
- 4.
- 5.
- 6.
- 7.
- 8.
- 9.
- 10.
- 11.
- 12.
- 13.

25x40

30

20

14.

30-35

220°

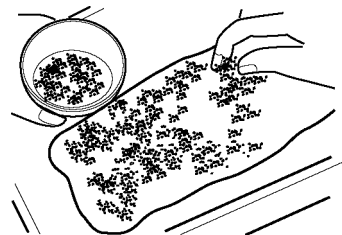
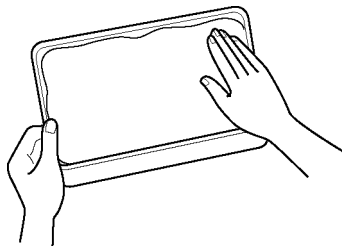
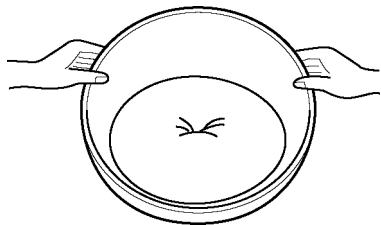

18

190°

:	:
	1,5
	3,25
	1,5
	2
	0,25
	0,25
	2

:2

- 1.
- 2.
- 3.
- 4.
- 5.
- 6.
- 7.
- 8.
- 9.
- 10.
- 11.
- 12.
- 13.
- 14.

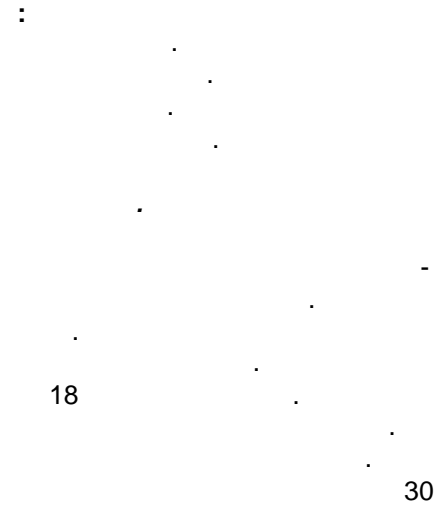

18

30

22-25

190°

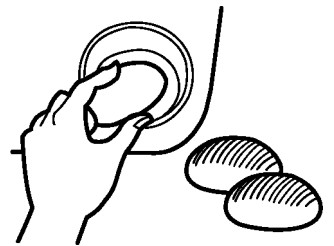
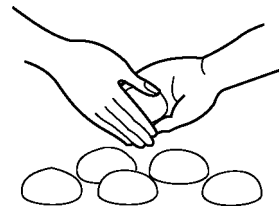
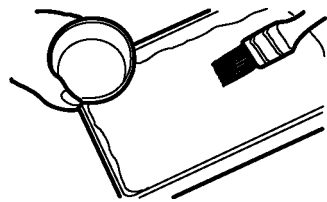
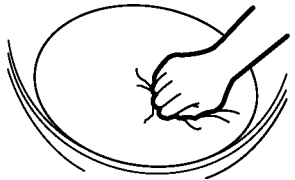

24

190 °

:	:
	1,25
	4 3/4
	1
	5
	0,25
	3
	2,5

- 1.
- 2.
- 3.
- 4.
- 5.
6. 24
7. 190 °  
25-30 24

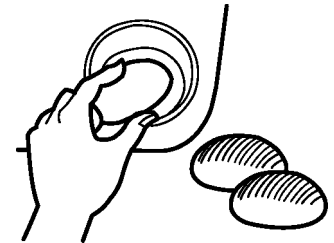
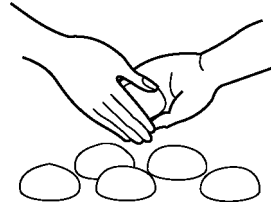
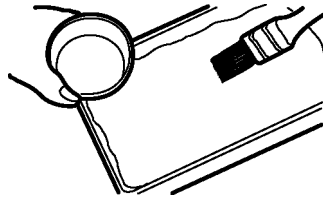
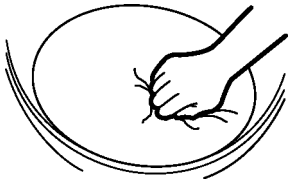

18

190 °

:	:
	1
	1
	3
	3
	1
	0,5
	2,5

«

:

1.

2.

3.

4.

5.

6.

6.

18

7.

190 °

22-25

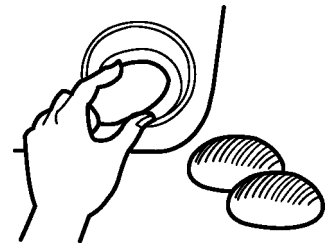
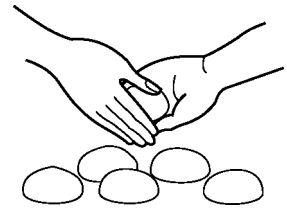
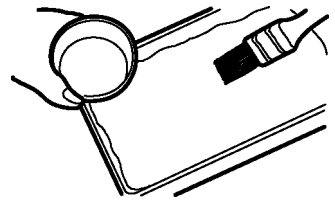
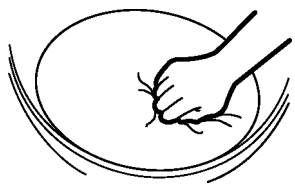

--

:	:
	500 .
	3/4
	1

1. :
2. .
3. .
4. , ,
5. .
6. .
7. .

:	:
	450 .
	5/8
	1

- :
- 1.
  - 2.
  - 3.
  - 4.
  - 5.
  - 6.
  - 7.





:	:
	540 .
	3/4
	1

1. :
2. .
3. .
4. .
5. , , ,
6. . . . .
7. . . . .
8. .

:	:
	500 .
	80 .
	3/4
	1

1. :
2. .
4. .
5. , , ,
6. .
7. .
8. .

:	:
	470 .
	3/4
	1

:

- 1.
- 2.
- 3.
- 4.
- 5.
- 6.
- 7.





**LG Electronics Inc.**

